

H5studio

Handy Recorder



Operation Manual

You must read the Usage and Safety Precautions before use.

©2025 ZOOM CORPORATION

Copying or reprinting this manual in part or in whole without permission is prohibited.

Product names, registered trademarks and company names in this document are the property of their respective companies. All trademarks and registered trademarks in this document are for identification purposes only and are not intended to infringe on the copyrights of their respective owners.

Proper display is not possible on grayscale devices.

Notes about this Operation Manual

You might need this manual in the future. Always keep it in a place where you can access it easily. The contents of this document and the specifications of the product could be changed without notice.

- Microsoft and Windows are trademarks of the Microsoft group of companies.
- Mac, macOS, iPad and Lightning are trademarks of Apple Inc.
- The iPhone trademark is used under license from Aiphone Co., Ltd.
- App Store is a service mark of Apple Inc.
- UltraSync BLUE is a trademark of ATOMOS/Timecode Systems Limited.
- The Bluetooth® word mark and logo are registered trademarks of Bluetooth SIG, Inc., and these marks are used under license by ZOOM CORPORATION.
- The microSDXC logo is a trademark of SD-3C LLC.
- USB Type-C is a trademark of the USB Implementers Forum.
- Recording from copyrighted sources, including CDs, records, tapes, live performances, video works and broadcasts, without permission of the copyright holder for any purpose other than personal use is prohibited by law. ZOOM CORPORATION will not assume any responsibility related to infringements of copyrights.

Contents

Notes about this Operation Manual.....	2
H5studio overview.....	6
XYH-5s overview.....	6
Recording examples.....	7
Achieving high audio quality throughout recording and editing.....	10
Functions of parts.....	14
Overview of screens that appear.....	19
Recording process.....	31
Making preparations.....	32
Inserting microSD cards.....	32
Supplying power.....	33
Connecting input devices.....	35
Turning the power on/off.....	39
Setting the guide sound (first time starting up).....	41
Setting the language shown (first time starting up).....	42
Setting the date format (first time starting up).....	43
Setting the date and time (first time starting up).....	44
Setting the type of batteries used (first time starting up).....	46
Preventing misoperation (HOLD function).....	47
Making input settings.....	48
Enabling tracks for recording.....	48
Converting mic capsule input to mono.....	49
Using plug-in power.....	51
Setting the input level (mic/line).....	52
Setting phantom power.....	54
Reducing noise (Low Cut).....	56
Setting the Advanced Limiter.....	57
Enabling stereo linking.....	59
Linking gain knobs.....	62
Adjusting input gain.....	64
Making output settings.....	65
Adjusting the line output level.....	65
Using a limiter on the line output.....	67
Recording.....	68
Monitoring input sounds.....	68
Adjusting the overall level balance.....	70
Making recording settings.....	71
Recording.....	82
Pausing recording.....	84
Adding marks during recording.....	84

Moving the file being recorded to the TRASH folder.....	85
Changing screen content.....	86
Playing recordings.....	87
Starting and stopping playback.....	87
Adjusting the track level balance.....	89
Setting repeat playback (Play Mode).....	90
Automatic volume adjustment during playback.....	91
Changing the playback speed.....	92
Repeating playback of a set interval (A-B repeat).....	93
Changing the file format and exporting files.....	95
Moving the file being played to the TRASH folder.....	98
Managing files.....	99
H5studio folder and file structure.....	99
Checking files.....	102
Using as an audio interface.....	103
For Windows.....	103
Connecting to computers, smartphones and tablets.....	104
Making input settings and monitoring adjustments.....	108
Making output settings.....	110
Recording on the H5studio while using it as an audio interface.....	113
Disconnecting from computers, smartphones and tablets.....	114
Transferring files to computers and other devices.....	115
Connecting to computers, smartphones and tablets.....	115
Disconnecting from computers, smartphones and tablets.....	117
Managing microSD cards.....	118
Formatting microSD cards.....	118
Testing microSD cards.....	119
Deleting files in the TRASH folder.....	122
Using timecode.....	123
Timecode overview.....	123
Connecting with an UltraSync BLUE.....	125
Making various settings.....	128
Setting the language shown.....	128
Setting the date and time.....	129
Setting the date format.....	131
Setting the display brightness.....	133
Setting the type of batteries used.....	134
Setting display power saving.....	136
Setting the time until the power turns off automatically.....	137
Using the guide sound accessibility feature.....	139
Setting the guide sound (Accessibility).....	139
Setting the guide sound volume.....	141
Checking guide sound information.....	143
Turning the guide sound on/off with a shortcut.....	144

Installing guide sounds.....	144
Restoring the factory default state.....	145
Managing the firmware.....	146
Checking firmware versions.....	146
Updating the firmware.....	147
Operating the H5studio from a smartphone or tablet.....	148
Checking timecode data.....	150
Disconnecting from smartphones and tablets.....	150
Checking the latest information for the H5studio.....	151
Using optional mic capsules.....	152
Using an SSH-6e.....	152
Setting the SSH-6e mode.....	153
Reducing noise when using an SSH-6e (Low Cut).....	155
Setting the Advanced Limiter for the SSH-6e.....	156
Linking L and R gain for the SSH-6e.....	158
Using an EXH-6e.....	160
Enabling the EXH-6e inputs.....	160
Setting EXH-6e stereo linking.....	162
Reducing noise when using an EXH-6e (Low Cut).....	164
Setting the Advanced Limiter for the EXH-6e.....	165
Linking A and B gain for the EXH-6e.....	167
Appendix.....	169
Troubleshooting.....	169
H5studio metadata list.....	172
Mixer block diagrams.....	175
Specifications.....	177

H5studio overview

XYH-5s overview

The H5studio includes an XYH-5s, which is an XY mic capsule.

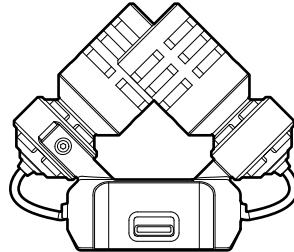

Characteristics

The XYH-5s is an XY stereo mic capsule that uses large diaphragms.

By having left and right diaphragms face inward perpendicularly to each other, a wide recording range can be covered while fully capturing sound sources in the center.

Moreover, since the points of recording are almost the same, no phase differences occur between the left and right channels.

Providing three-dimensional sound with natural depth and width, this recording technique is ideal for capturing specific sound sources that are nearby or at medium distance.

Use examples: solo and chamber music performances, live rehearsals, field recordings, etc.

Recording examples

Example 1: Recording performances with a voice and instrument

The sound of an instrument being played can be recorded using the H5studio mic capsule while vocals are recorded with a connected mic.



Example 2: Concert recording

The sounds of the performance and the audience can be recorded using the H5studio mic capsule while a stereo mix or individual channels are recorded separately from a mixer.

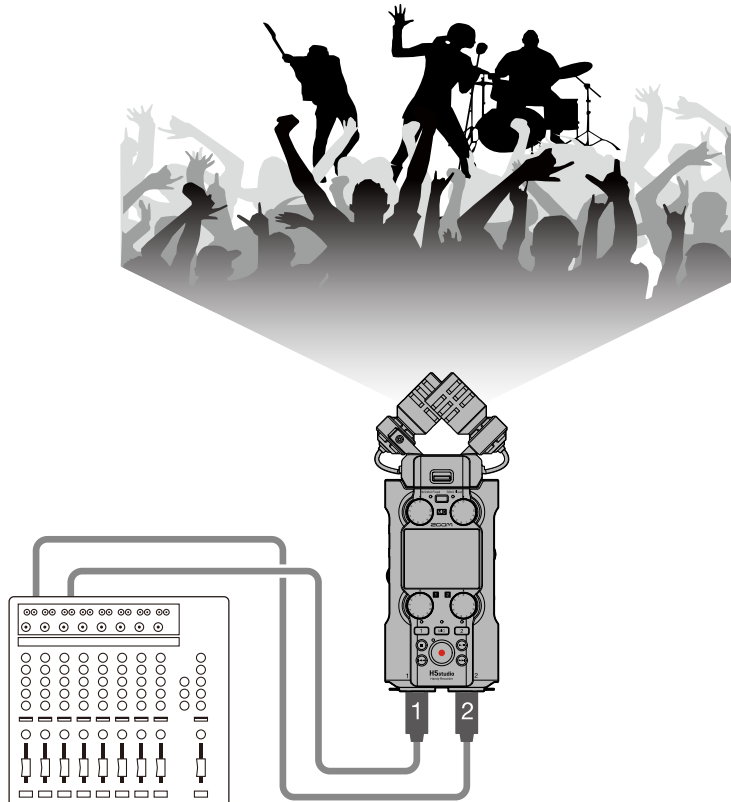

Example 3: Live streaming of podcasts

Audio can be streamed in real time using the H5studio and connected mics. (→ [Using as an audio interface](#))
While streaming audio in real time, the H5studio can simultaneously record. (→ [Recording on the H5studio while using it as an audio interface](#))



Example 4: Capturing video

Audio and video can be captured simultaneously using the H5studio and a camera.

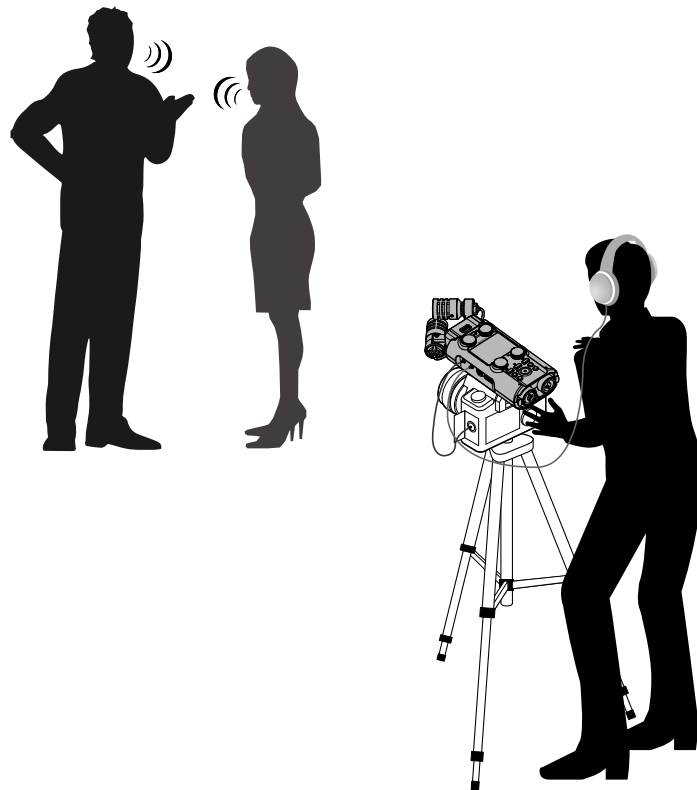

HINT

If the H5studio is placed directly on a table when recording using its mic capsule, reflected sound could interfere with recording and reduce clarity. We recommend using a tripod, for example, to distance it from the table. Placing something like a handkerchief can also be effective in reducing sound reflected from a table.

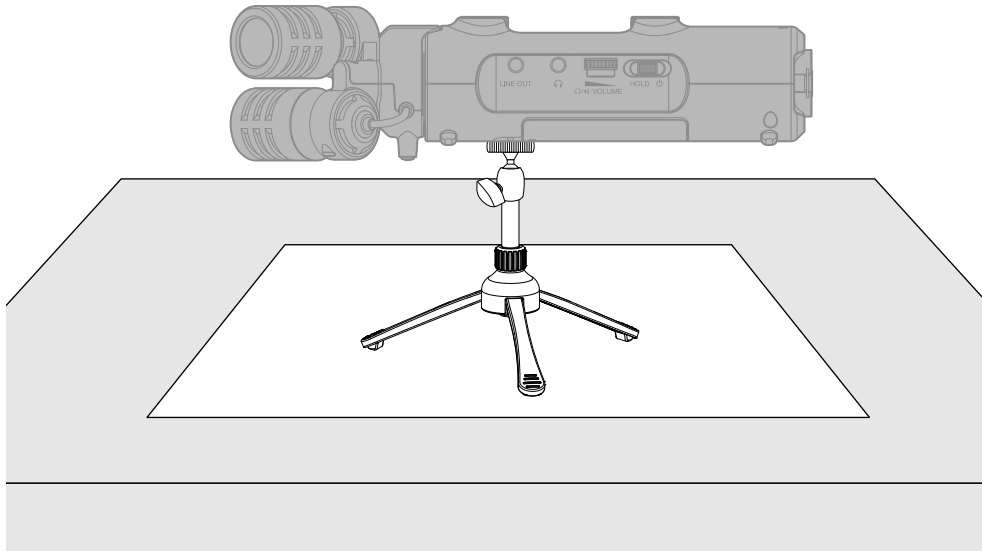

Achieving high audio quality throughout recording and editing

With dual A/D converter circuits and support for 32-bit float WAV files, the H5studio can maintain the highest audio quality from recording through editing in a DAW or other software.

Recording

Dual A/D converter circuits enable recording both loud and quiet sounds without making gain adjustments.



Editing with DAWs and other software

Since files are recorded using 32-bit float WAV format, audio quality can be retained when editing.



HINT

Recording with conventional 16/24-bit WAV file formats is also possible. (→ [Setting the recording mode](#))

Dual A/D converter circuit overview

For each input circuit, the H5studio has two A/D converters with different input gains. This design enables high-quality audio recording without the need to adjust gain settings, a step that is normally indispensable.

Providing amazing dynamic range

By combining two A/D converters, a wide dynamic range not possible with a single A/D converter has been realized.

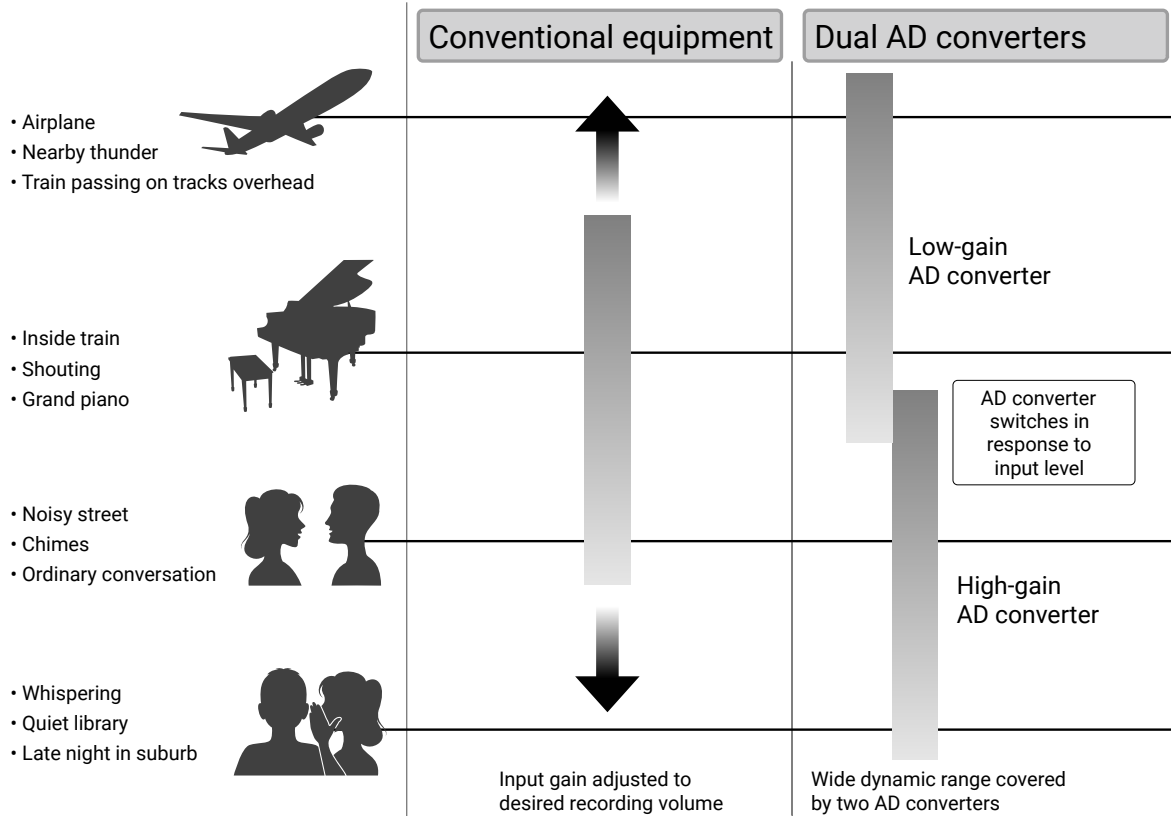

Switching between two A/D converters

The H5studio constantly monitors data from the two A/D converters and automatically selects the one that provides the best recording results.

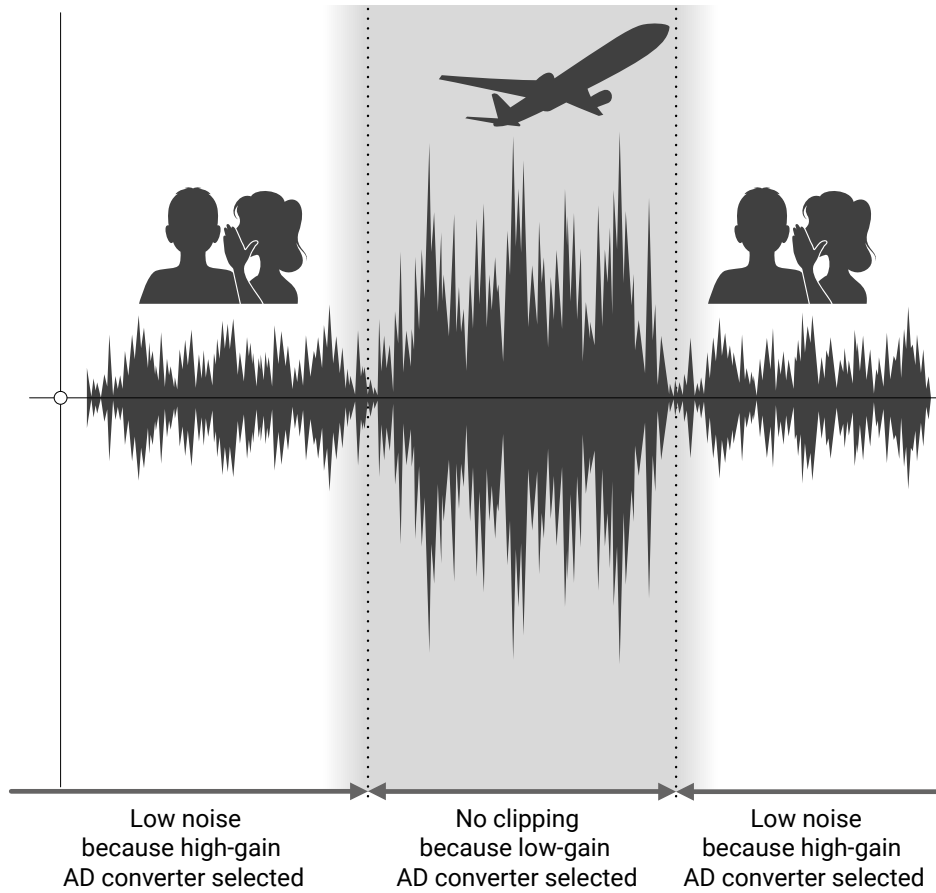

32-bit float WAV file overview

32-bit float WAV files have the following advantages over conventional 16/24-bit WAV files.

These advantages allow the recording audio quality to be preserved even when editing in a DAW or other software after recording.

Resolution advantage

32-bit float WAV files have the advantage of being able to maintain high resolution even at low volumes. As a result, quiet sounds can be made louder when editing after recording without degrading their quality.

■ 16/24-bit WAV

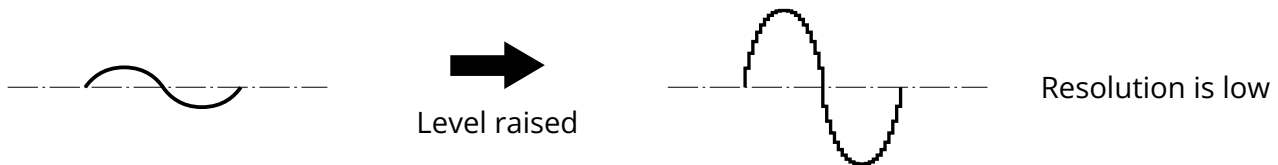

■ 32-bit float WAV

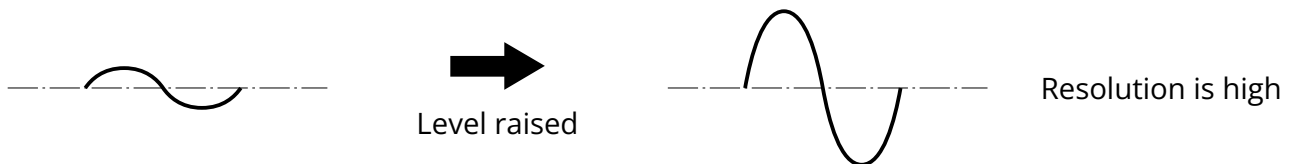

Clipping advantage

If a waveform sounds clipped when output from the H5studio or in a DAW, it can be edited after recording to lower its volume and restore an unclipped waveform because the data in the 32-bit float WAV file itself is not clipped.

■ 16/24-bit WAV

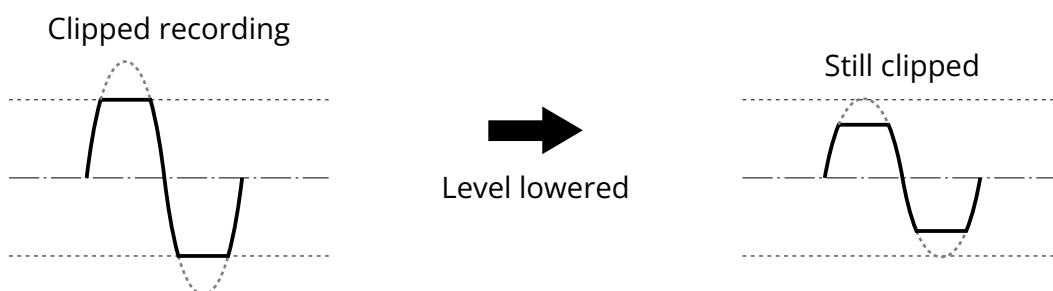

■ 32-bit float WAV

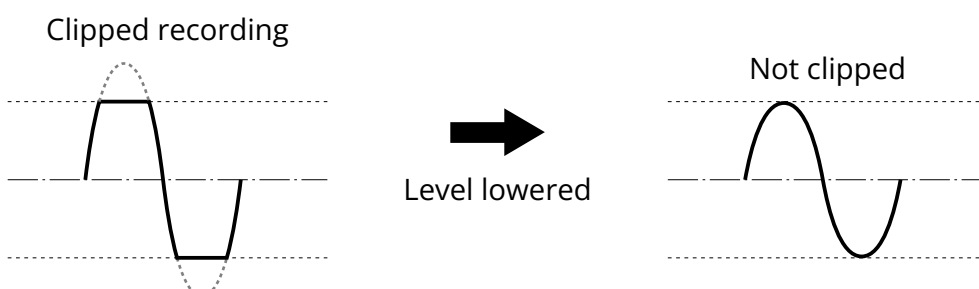

Functions of parts

Front and back

■ Front

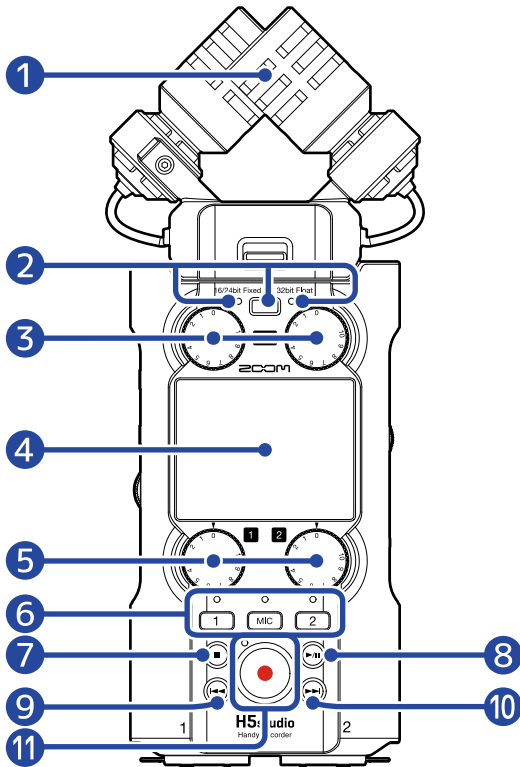

■ Back

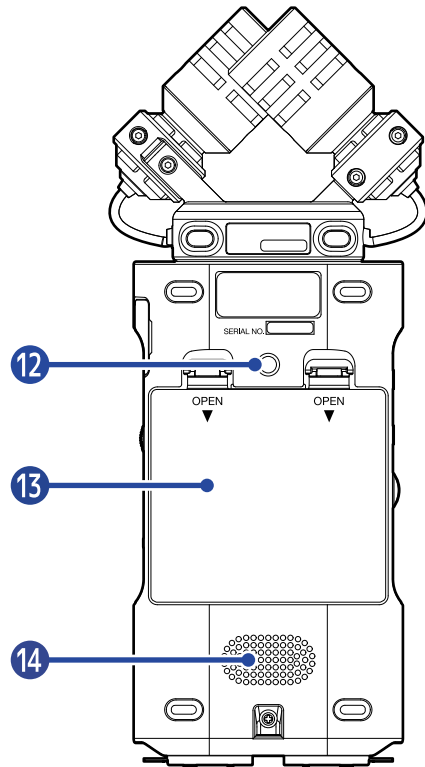

1 Mic capsule (XYH-5s)

This stereo mic has two crossing directional mics. This mic can record three-dimensional sound with natural depth and width. (→ [XYH-5s overview](#))

2 Recording Mode button and indicator

Push this to change the recording mode.

The indicator to the left of the button will light when in 16/24-bit fixed mode and the indicator to the right will light when in 32-bit float mode. (→ [Setting the recording mode](#))

3 MIC GAIN knobs

Use these to adjust the mic input levels.

4 Display

This shows various types of information.

5 INPUT 1/2 GAIN knobs

Use these to adjust the input levels of INPUT 1 and 2.

6 Track buttons and status indicators

Press a track button, lighting its status indicator red, to enable that track for recording.

7 STOP button

This stops recording/playback.

Press this when the [Playback Screen](#) or a settings screen is open to return to the [Home Screen](#) (with some exceptions).

8 [PLAY/PAUSE button](#)

This starts and pauses playback.

9 [REW button](#)

Press this during playback or when paused to move to the previous file, the beginning of the file, or the previous mark.

Press and hold this to search backward.

10 [FF button](#)

Press this during playback or when paused to move to the next file or the next mark.

Press and hold this to search forward.

11 [REC button and indicator](#)

This starts recording. The indicator lights during recording.

Press this when recording to stop recording.

12 [Tripod socket](#)

This can be used to attach the H5studio to a tripod, for example.

13 [Battery cover](#)

Open this when installing or removing AA batteries. (→ [Installing batteries](#))

14 [Speaker](#)

This outputs sound during file playback.

If headphones are connected to the Headphone jack, sound will not be output from the speaker.

Left and right sides

■ Left side

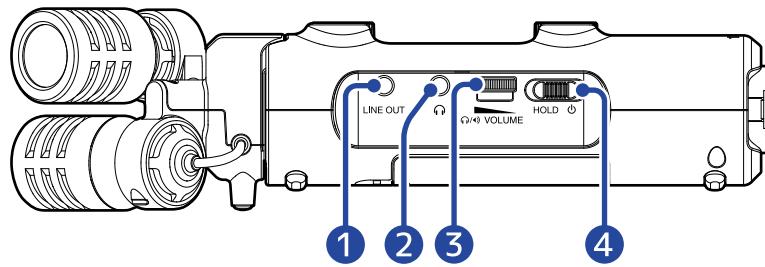

■ Right side

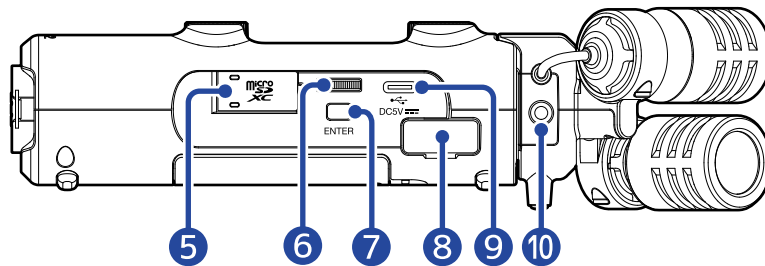

1 LINE OUT jack

This outputs sound to a connected device.

2 Headphone jack

This can output sound to headphones.

3 VOLUME dial

Use this to adjust the volume output from the built-in speaker and headphones.

4 POWER/HOLD switch

Use this to turn the power on/off and to disable button operation.

5 microSD card slot

Insert a microSD card here.

6 Selection dial

Use this to select items.

7 ENTER button

Use this to confirm items.

8 REMOTE connector

The following functions become possible if a ZOOM BTA-1 or another dedicated adapter (sold separately) is connected here.

- Wirelessly control the H5studio from an iPhone/iPad using the ZOOM Handy Control & Sync app.
- Record timecode in H5studio files by connecting an UltraSync BLUE made by ATOMOS/Timecode Systems.

9 USB port (Type-C)

Connect this to a computer, smartphone or tablet to use the H5studio as an audio interface and for file transfer.

This supports operation with USB bus power.

Use a USB cable that supports data transfer.

10 MIC/LINE IN jack (supports plug-in power)

If an external mic or line device is connected here, it can be used to record instead of the XY mic.

This can also provide plug-in power to mics that require it.

Bottom end

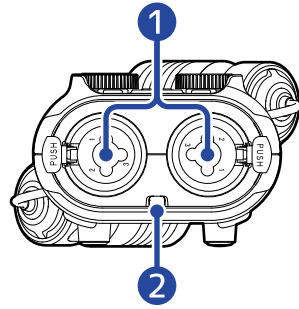

1 INPUT 1 and 2 jacks

Connect mics and instruments to these. These can be used with XLR and TRS plugs. When disconnecting an XLR plug, pull it while pushing the connector lock release button.

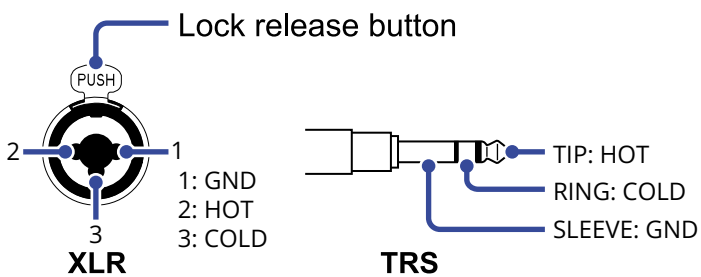

2 Strap hole

Use this to attach a strap.

Overview of screens that appear

In this section, we explain the screens shown on the display of the H5studio.

Home Screen

This screen appears on the display when the H5studio power is turned on. This shows the state of the H5studio, including recording status and input signal waveforms.

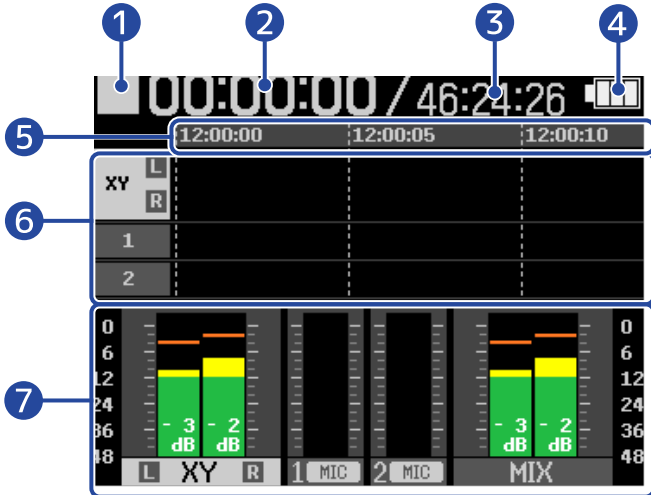

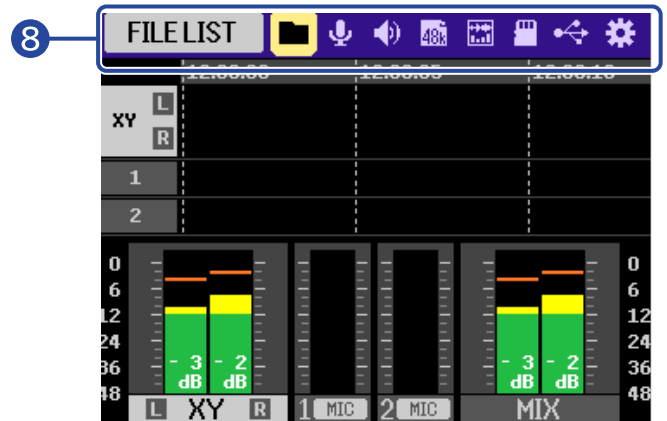

When Menu bar shown



1 Status icon

The recording status is shown by an icon.

-  : Stopped
-  : Recording
-  : Recording paused

2 Elapsed recording time

This shows the current elapsed recording time.

3 Remaining Time

This shows the current available recording time.

4 Remaining battery indicator

This is shown when operating on batteries. When the remaining battery charge becomes low, replace the batteries (→ [Installing batteries](#)) or connect an AC adapter (→ [Connecting an AC adapter](#)) or portable battery (→ [Using other power sources](#)).



5 Time display



This shows the current time.

6 Waveform display (MIC capsule, INPUT 1/2)

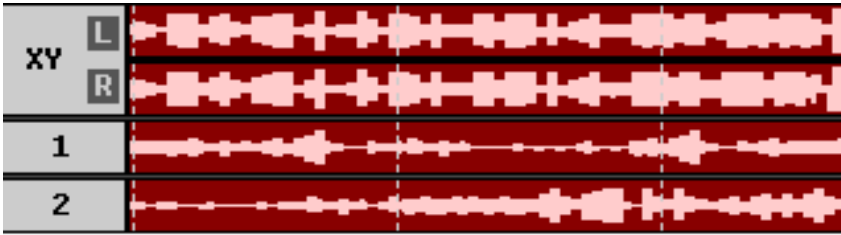
This shows the waveforms of the signals being recorded on the tracks.

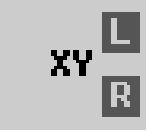

The input types are shown at the left end of each waveform.

-  : Mic capsule L/R
-  : INPUT 1
-  : INPUT 2

The following will be shown when a track is off. (→ [Enabling tracks for recording](#))

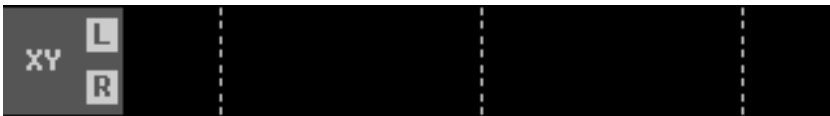

The following will be shown when a track is stereo. (→ [Enabling stereo linking](#))



7 Level meters (MIC (mic capsule), INPUT 1/2, stereo mix)

This shows the levels of the signals being input on the tracks.



When the recording mode is "16/24bit Fixed", clipping indicators will be shown at the tops of the level meters if input signals clip. (→ [Setting the recording mode](#))

Peak values are shown at the bottom of the level meters.

From the left, the level meters are for the MIC (mic capsule), INPUT1, INPUT2 and stereo mix tracks.

The stereo mix track might not be shown depending on the settings. (→ [Setting whether to record mix files](#))

The input types are shown at the bottom of each level meter.

-  : Mic capsule L/R
-  : INPUT 1 with input level set to mic and phantom on.
-  : INPUT 2 with input level set to line and phantom off.

The following will be shown when a track is off. (→ [Enabling tracks for recording](#))

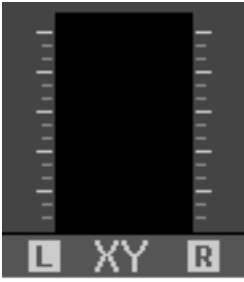

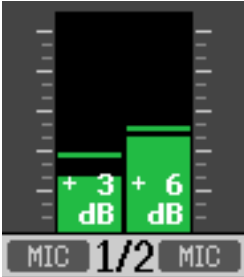

The following will be shown when a track is stereo. (→ [Enabling stereo linking](#))



8 Menu bar

Turn the  (selection) dial to show the Menu Bar at the top of the screen.







This shows icons for various setting items so settings screens, including input, output, recording and system, can be opened and settings can be made easily.



Use the  (selection) dial to select an icon, and press the  (ENTER) button to conduct the following operations.

■ When recording paused



The name of the currently selected item is shown at the left end of the Menu bar.





-  FILE LIST: This opens the File List Screen where the files on the microSD card can be checked. (→ [File List Screen](#))
-  INPUT: This opens a screen with settings related to input. (→ [Making input settings](#))
-  OUTPUT: This opens a screen with settings related to output. (→ [Making output settings](#))
-  RECORDING: This opens a screen with settings related to recording. (→ [Making recording settings](#))
-  DISPLAY: The Home Screen can be set to show level meters only, waveforms only or level meters and waveforms. (→ [Changing screen content](#))
-  SD CARD: This opens a screen with settings related to microSD cards. (→ [Managing microSD cards](#))

-  USB: This opens a screen to connect the H5studio to a computer, smartphone or tablet in order to check and move files on the microSD card and make audio interface settings. (→ [Transferring files to computers and other devices](#), [Using as an audio interface](#))
-  SYSTEM: This opens a screen where various unit settings, including date/time and display settings, can be made. (→ [Making various settings](#))



■ When recording



The name of the currently selected item is shown at the left end of the Menu bar.

-  MARK: Use this to add marks to the file being recorded. (→ [Adding marks during recording](#))
-  OUTPUT: This opens a screen with settings related to output. (→ [Making output settings](#))
-  DISPLAY: The Home Screen can be set to show level meters only, waveforms only or level meters and waveforms. (→ [Changing screen content](#))
-  TRASH: Use this to move the file being recorded to the trash. (→ [Moving the file being recorded to the TRASH folder](#))

HINT

- When the [Playback Screen](#) or a settings screen is open, press the  (STOP) button to return to the Home Screen. This function is useful when you want to return to the Home Screen quickly from various setting screens. (Moving to the Home Screen is not possible from some screens.)
 - Clip indicators can be cleared when recording is paused by pressing and holding the  (STOP) button.
-

Playback Screen



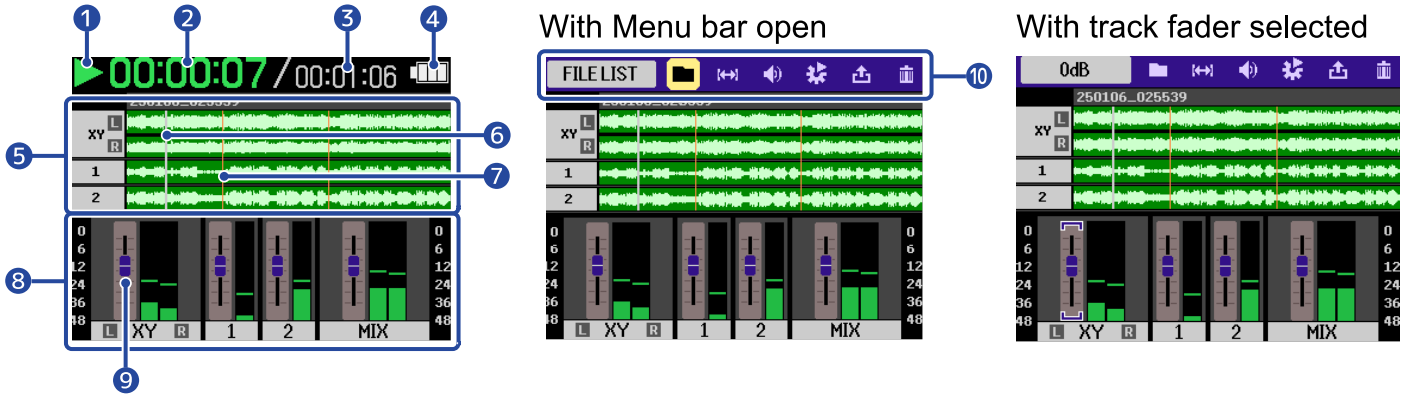

When the [Home Screen](#) is open, pressing the  (PLAY/PAUSE) button to start playback will open this screen on the display.

This shows the H5studio playback information, including the playback time and recording file waveforms.



1 Status icon

The playback status is shown by an icon.

-  : Playing back
-  : Paused
-  : Searching backward
-  : Searching forward

2 Playback time

This shows the elapsed time since the start of playback.

3 File length

This shows the length of the file currently playing.

4 Remaining battery indicator

This is shown when operating on batteries. When the remaining battery charge becomes low, replace the batteries (→ [Installing batteries](#)) or connect an AC adapter (→ [Connecting an AC adapter](#)) or portable battery (→ [Using other power sources](#)).



5 Waveform display (MIC capsule, INPUT 1/2)

This shows the waveforms of the recorded files being played.

The positions of markers can also be checked. (→ [Adding marks during recording](#))

The input types are shown at the left end of each waveform.

-  : Mic capsule L/R

- **1** : INPUT 1
- **2** : INPUT 2

6 Playback position bar

This shows the current playback location.

7 Mark bar

This shows marks added to the file being played back.

8 Level meters (MIC (mic capsule), INPUT 1/2, stereo mix)

This shows the levels of the tracks.

From the left, the level meters are for the MIC (mic capsule), INPUT1, INPUT2 and stereo mix tracks. The input types are shown at the bottom of each level meter.

- **L XY R** : Mic capsule L/R
- **1** : INPUT 1
- **2** : INPUT 2

The waveform will be shown in gray when a track is off.



9 Faders



Use this to adjust the levels of the tracks. (→ [Adjusting the track level balance](#))

The current fader value is shown at the top left of the screen.

10 Menu bar

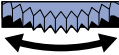

Turn the  (selection) dial to show the Menu Bar at the top of the screen.



This shows icons for various setting items so settings screens, including output and repeat, can be opened and settings can be made easily.

Use the  (selection) dial to select an icon, and press the  (ENTER) button to conduct the following operations.





The name of the currently selected item is shown at the left end of the Menu bar.

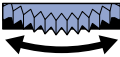

-  File List: This opens the File List Screen where the files on the microSD card can be checked. (→ [File List Screen](#))
-  A-B Repeat: Use this to set the starting and ending points for repeat playback. (→ [Repeating playback of a set interval \(A-B repeat\)](#))
-  OUTPUT: This opens a screen with settings related to output. (→ [Making output settings](#))

-  Option: This opens the Playback Option Screen. (→ [Setting repeat playback \(Play Mode\)](#), [Automatic volume adjustment during playback](#), [Changing the playback speed](#))
 -  Export: Use this to change the format, for example, of the playing file and export it. (→ [Changing the file format and exporting files](#))
 -  Trash: Use this to move the file being recorded to the trash. (→ [Moving the file being played to the TRASH folder](#))
-

HINT

- Press the  (STOP) button to stop playback and return to the [Home Screen](#).
 - When the [File List Screen](#) is open, use the  (selection) dial to select  (Play View) in the Menu bar and press the  (ENTER) button to open the [Playback Screen](#).
-

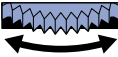

File List Screen

When the [Home Screen](#) or [Playback Screen](#) is open, use the  (selection) dial to select  (File List) and press the  (ENTER) button to open it.

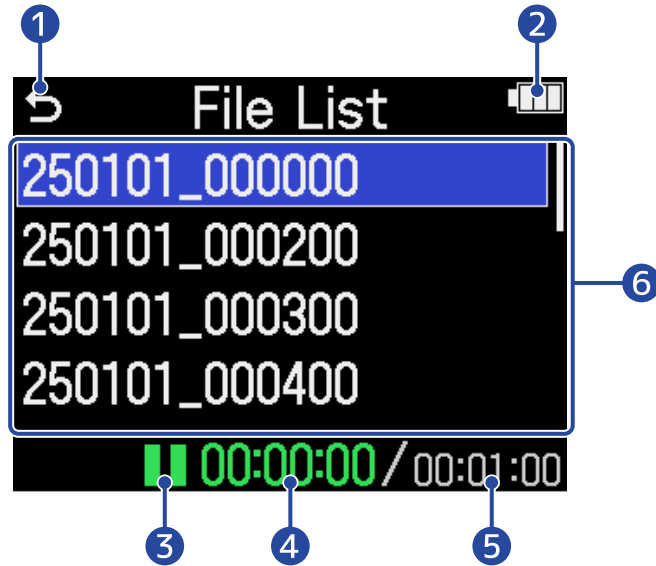
This lists the files on the microSD card on the display, allowing the content of the card to be checked and files to be played and moved to the trash, for example.

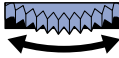

1

Use the  (selection) dial to select this and press the  (ENTER) button to return to the [Home Screen](#) or [Playback Screen](#).





2 Remaining battery indicator

This is shown when operating on batteries. When the remaining battery charge becomes low, replace the batteries (→ [Installing batteries](#)) or connect an AC adapter (→ [Connecting an AC adapter](#)) or portable battery (→ [Using other power sources](#)).



3 Status icon

The playback status is shown by an icon.

- : Playing back
- : Paused
- : Searching backward
- : Searching forward

4 Playback time



This shows the elapsed time since the start of playback.

5 File length

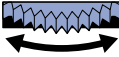

This shows the length of the currently selected file.

6 File list

This shows the files on the microSD card in a list.

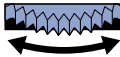

- Use the  (selection) dial to select files.
- When a list has more files than will fit on the display, a scrollbar will appear on the right edge.
- Use the  (selection) dial to select a file and press the  (ENTER) button to show the Menu bar at the top of the screen.

Menu bar

Use the  (selection) dial to select a setting item, and press the  (ENTER) button to conduct the following operations.



The name of the currently selected item is shown at the left end of the Menu bar.



-  BACK: This closes the Menu bar and enables file selection again.
-  PLAY VIEW: This opens the Playback Screen for the selected file. (→ [Playback Screen](#))
-  TRASH: Use this to move the selected file to the trash. (→ [Moving the file being played to the TRASH folder](#))

HINT

Press the  (STOP) button to return to the [Home Screen](#).

Input Settings Screen

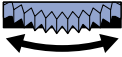
Use this screen to make settings related to inputs.

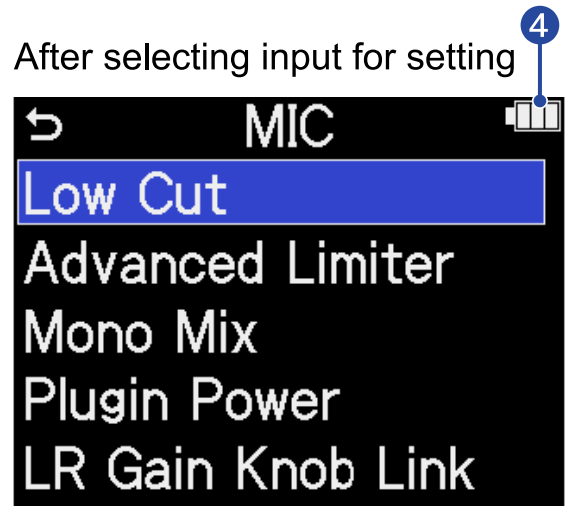
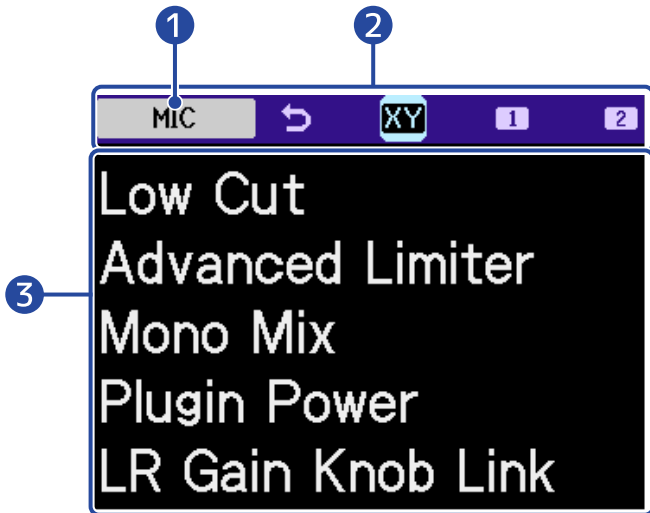

Use the  (selection) dial to select a setting item or value, and press the  (ENTER) button to confirm.



1 Name of input being set



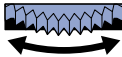

2 Menu bar

The inputs that can be set are shown by icons.

Use the  (selection) dial to select an input, and press the  (ENTER) button to make settings for that input.



The name of the currently selected item is shown at the left end of the Menu bar.

-  BACK: Return to the [Home Screen](#).
-  MIC: Make settings for the mic capsule.
-  INPUT 1,  INPUT 2: Make settings for INPUT 1/2.

3 Setting items

4 Remaining battery indicator

This is shown when operating on batteries. When the remaining battery charge becomes low, replace the batteries (→ [Installing batteries](#)) or connect an AC adapter (→ [Connecting an AC adapter](#)) or portable battery (→ [Using other power sources](#)).





HINT

Press the  (STOP) button to return to the [Home Screen](#).

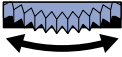

Other settings screens

Other screens can be used to make settings related to output, recording, SD cards, USB and the system.

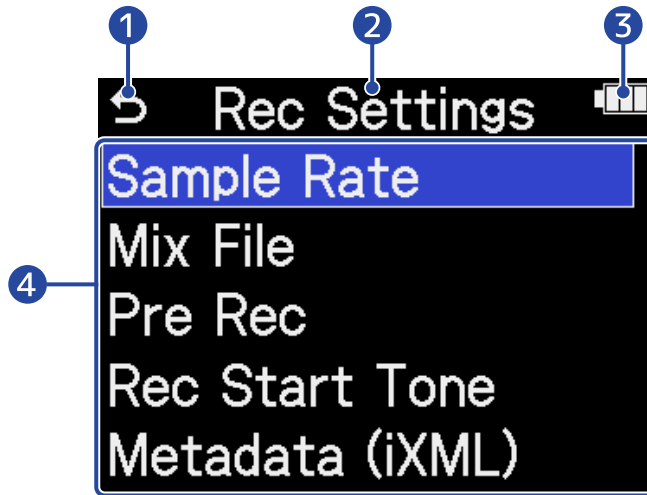
Use the  (selection) dial to select a setting item or value, and press the  (ENTER) button to confirm.

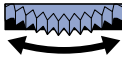

1 

Use the  (selection) dial to select this and press the  (ENTER) button to return to the [Home Screen](#).

2 Setting screen name

3 Remaining battery indicator

This is shown when operating on batteries. When the remaining battery charge becomes low, replace the batteries (→ [Installing batteries](#)) or connect an AC adapter (→ [Connecting an AC adapter](#)) or portable battery (→ [Using other power sources](#)).



4 Setting items



Recording process

Recording follows the process shown below.



Prepare to record

- Load a microSD card. (→ [Inserting microSD cards](#))
- Prepare the power. (→ [Installing batteries](#), [Connecting an AC adapter](#))
- Connect mics, for example, to inputs. (→ [Connecting input devices](#))
- Turn the power on. (→ [Turning on the power](#))
- Make settings related to input. (→ [Making input settings](#))
- Make settings related to recording. (→ [Making recording settings](#))

Record

- Press the  (REC) button to start recording and press the  (REC) or  (STOP) button to stop recording. (→ [Recording](#))

Play and check
recording

- Press the  (PLAY/PAUSE) button to start playback and press the  (STOP) button to stop it. (→ [Playing recordings](#))

Making preparations

Inserting microSD cards

1. When the power is off, open the microSD card slot cover, and insert a microSD card with the logo facing up all the way into the slot.

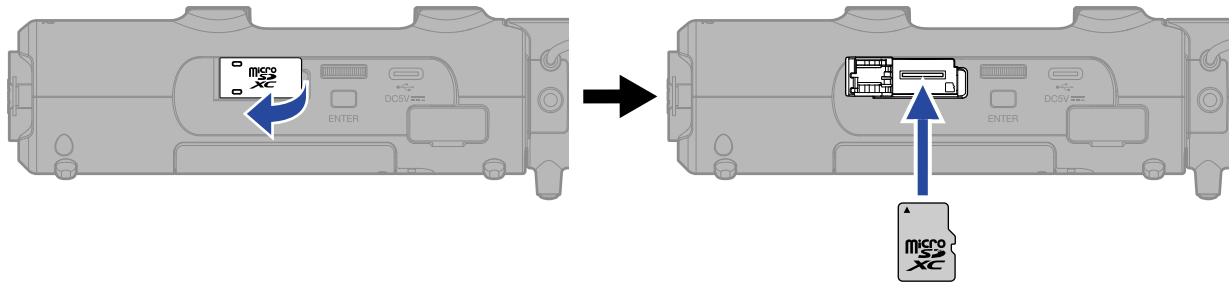



To remove a microSD card, push it further into the slot and then pull it out.

2. Close the microSD card slot cover.

NOTE

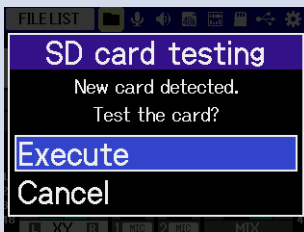
- Always make certain that the power is off when inserting or removing a microSD card. Inserting or removing a card while the power is on could result in data loss.
- When inserting a microSD card, be sure to do so with the correct orientation and facing.
- Recording and playback are not possible when a microSD card is not loaded in the H5studio.
- When an SD card that has not been used with the H5studio before is loaded in it, an SD card test screen will open.

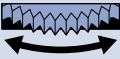

Use the  (selection) dial to select "Execute" and press the  (ENTER) button to open the SD card screen and test the card. (→ [Testing microSD cards](#))

- The following types of recording media are supported.
 - microSDHC memory cards
 - microSDXC memory cards

See the ZOOM website (zoomcorp.com/help/h5studio) for information about microSD cards that have been confirmed to work with this unit.

Supplying power

The H5studio can operate using batteries or a power supply connected to the USB port (AC adapter, USB bus power or portable battery).

Power from a power supply connected to the USB port will be used before batteries.

Installing batteries

To power the H5studio with batteries, use 4 AA batteries.

1. When the power is off, push the latches up to open the battery cover.

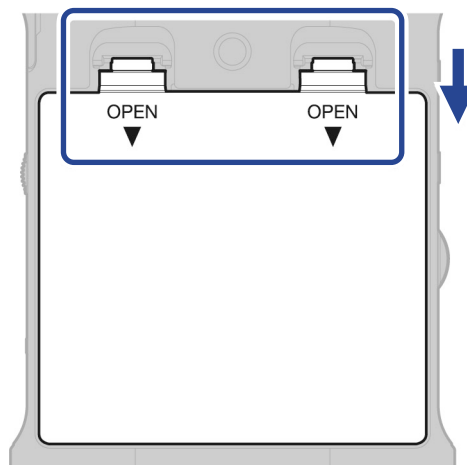

2. Install 4 AA batteries.
Spread the ribbon under the batteries.

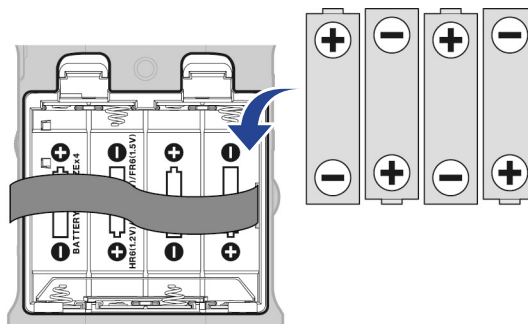

3. Replace the battery cover.

NOTE

- Use only one type of battery (alkaline, NiMH or lithium) at a time.
- Set the type of battery used correctly so that the amount of remaining battery charge can be shown accurately. (→ [Setting the type of batteries used](#))
- If the batteries run out of charge, turn the power off immediately and install new batteries. The battery charge will always be shown when operating on battery power.

Connecting an AC adapter

Connect the cable of a dedicated AC adapter (AD-17) to the USB port (Type-C) and connect the adapter to an outlet.

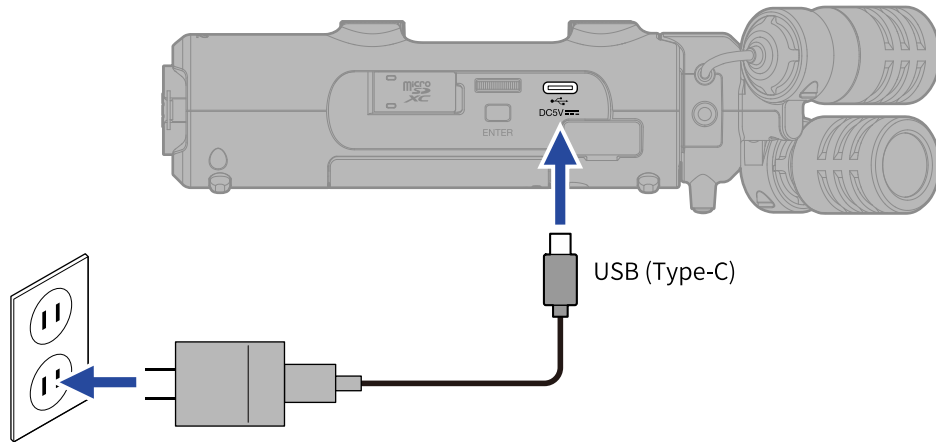

Using other power sources

By connecting the USB port (Type-C) to a computer, the H5studio can be operated using USB bus power. A 5V mobile battery (commercially-available) can also be used to provide power.

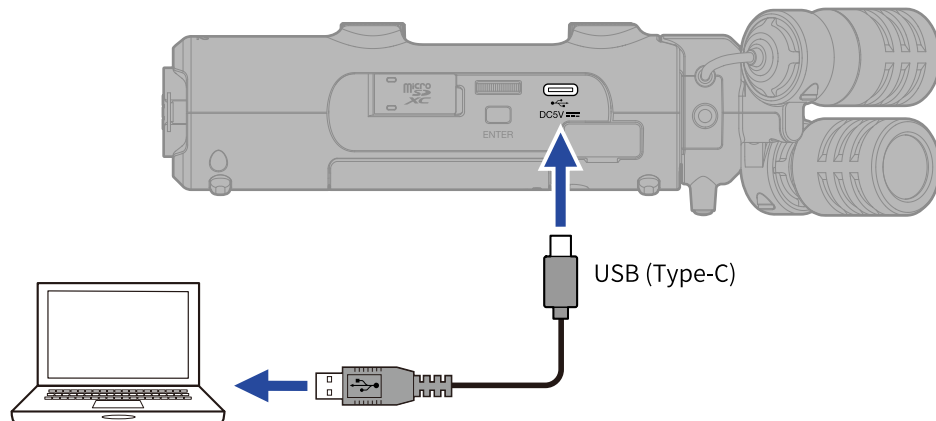

Connecting input devices

Attaching mic capsules

- 1.** Attach the mic capsule to the H5studio.
Align the protrusions on the mic capsule with the grooves on the H5studio and slide it until it clicks into place.

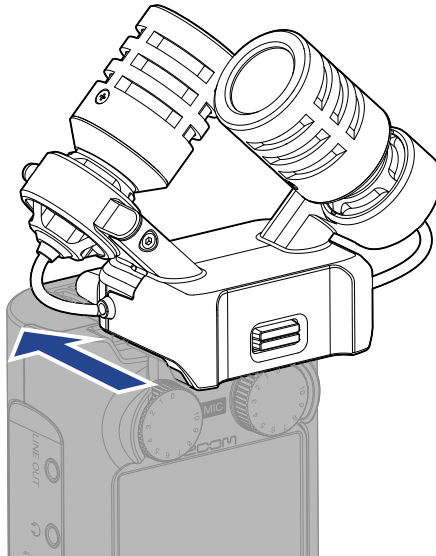

Disconnecting mic capsules

1. While pressing the mic capsule lock button up (①), slide it forward (②) and remove it.

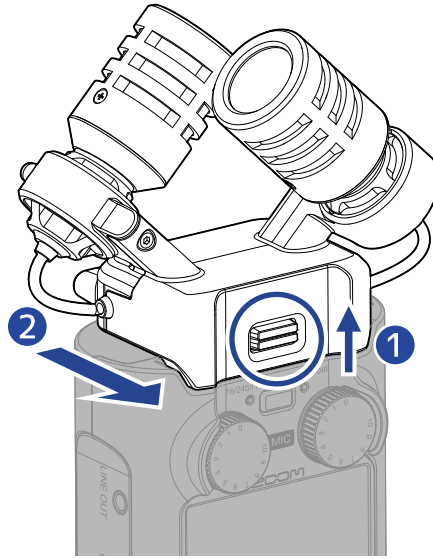

NOTE

- Do not use too much force when disconnecting. Doing so could damage the mic or the main unit.
- Always make certain that the power is off when connecting and disconnecting mic capsules.

Connecting a lavalier mic, for example, to the MIC/LINE IN jack

The XYH-5s mic capsule, which is included with the H5studio, has a MIC/LINE IN jack that can be used to connect an external mic or line-level device.

This jack can also provide plug-in power to mics that use it.

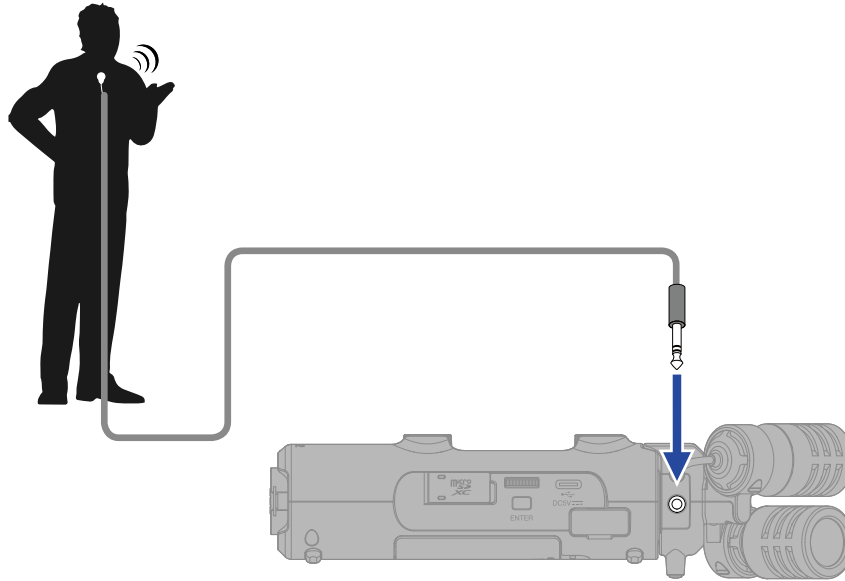

NOTE

- When using a lavalier mic, enable plug-in power. (→ [Using plug-in power](#))
- When using the MIC/LINE IN jack, the XYH-5s mic cannot also be used.

Connecting mics and other devices to INPUT 1 and 2

In addition to input from the mic capsule, the H5studio also has INPUT 1 and 2. These can be used together to input up to 4 channels.

Mics, mixers and other devices can be connected to INPUT 1 and 2.

■ Connecting mics

Connect dynamic and condenser mics with XLR plugs to INPUT 1 and 2.

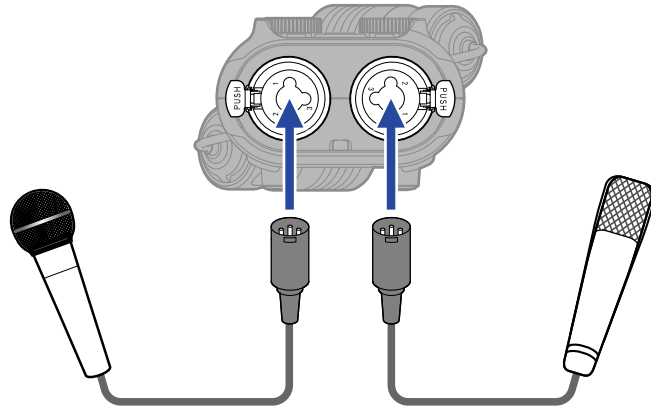

- From the Menu, set the input level setting to “Mic”. (→ [Setting the input level \(mic/line\)](#))
- Phantom power (+48V) can be supplied to condenser mics. (→ [Setting phantom power](#))
- When disconnecting a mic, pull the XLR plug while pushing the connector lock release button.

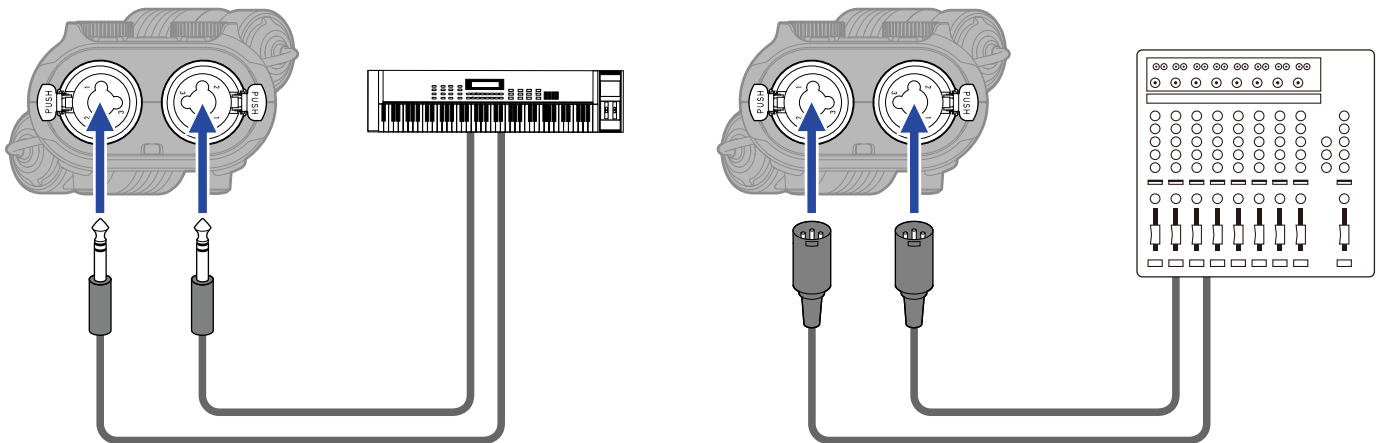

■ Connecting line level equipment



- From the Menu, set the input level to “Line”. (→ [Setting the input level \(mic/line\)](#))
- Direct input of passive guitars and basses is not supported. Connect these instruments through a mixer or effects device.

Turning the power on/off

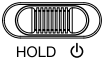
Turning on the power

1. Slide the  (POWER/HOLD) switch toward  (in the direction of the INPUT 1 and 2 jacks) until the display becomes active.

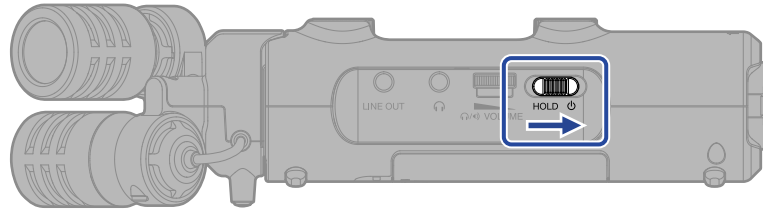

After the Startup Screen is shown, the [Home Screen](#) will open on the display.

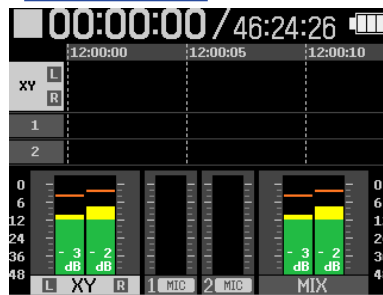



The first time the power is turned on after purchase as well as when the H5studio has been reset to factory defaults, setting screens for the guide sound, display language and date and time will be shown. Make these settings. (→ [Setting the guide sound \(first time starting up\)](#), [Setting the language shown \(first time starting up\)](#), [Setting the date format \(first time starting up\)](#), [Setting the date and time \(first time starting up\)](#), [Setting the type of batteries used \(first time starting up\)](#))

NOTE

- The H5studio can be set so that its power will automatically turn off if it is not used for a set amount of time. (→ [Setting the time until the power turns off automatically](#))
- If “No SD Card” appears on the display, confirm that a microSD card is inserted properly. (→ [Inserting microSD cards](#))
- If “Invalid SD Card” appears on the display, the card is not formatted correctly. Format the microSD card or use a different microSD card. (→ [Formatting microSD cards](#), [Inserting microSD cards](#))

■ Turning off the power



1. Slide the  (POWER/HOLD) switch toward  (toward the INPUT 1 and 2 jacks) until “Saving data” appears on the display.
The display will darken and the power will turn off.

NOTE

- While “Saving data” is shown, the current settings of the H5studio are being saved. While “Saving data” is shown, do not disconnect the AC adapter or remove the batteries.
- The power cannot be turned off while recording. Turn the power off after recording stops.

Setting the guide sound (first time starting up)

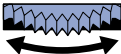
Set the guide sound when a screen to set it is shown the first time the power is turned on after purchase or after the H5studio has been reset to factory defaults.

1. Use the  (selection) dial to select the setting item and press the  (ENTER) button.

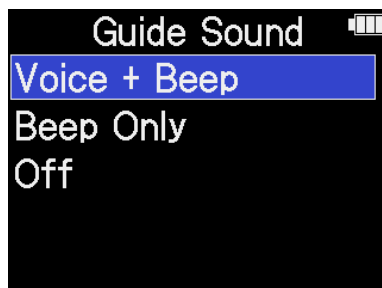

Setting value	Explanation
Voice + Beep	Setting items will be read aloud in the installed language. A beeping sound will be used to notify the occurrence of error messages, recording starting/stopping and volume adjustment, for example. English is installed at the time of purchase, but other languages can be installed and used for reading as desired. (→ Installing guide sounds)
Beep Only	A beeping sound will be used to notify when error messages occur, recording starts/stops and the volume changes, for example. Nothing will be read aloud.
Off	This turns off the guide sound.

After the guide sound setting is confirmed, set the language shown when a screen to set it opens. (→ [Setting the language shown \(first time starting up\)](#))

NOTE



The volume of the guide sound can also be adjusted. (→ [Setting the guide sound volume](#))

HINT

- The guide sound setting can also be changed later on the System Settings Screen. (→ [Setting the guide sound \(Accessibility\)](#))
- The guide sound can be turned on/off immediately by pressing and holding the  (ENTER) button when the Home Screen is open. (→ [Turning the guide sound on/off with a shortcut](#))

Setting the language shown (first time starting up)



Set the display language when a screen to set it is shown after setting the guide sound the first time the power is turned on after purchase or after the H5studio has been reset to factory defaults.

1. Use the  (selection) dial to select the display language and press the  (ENTER) button.



After the display language setting is confirmed, set the date format when a screen to set it opens.
(→ [Setting the date format \(first time starting up\)](#))



HINT

- The display language setting can also be changed later on the System Settings Screen. (→ [Setting the language shown](#))
 - Use the  (selection) dial to select  and press the  (ENTER) button to return to the previous setting screen.
-

Setting the date format (first time starting up)

Set the date format when a screen to set it is shown after setting the display language the first time the power is turned on after purchase or after the H5studio has been reset to factory defaults.

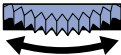
The date written to recorded files will use the date format selected here.

1. Use the  (selection) dial to select the date format and press the  (ENTER) button.

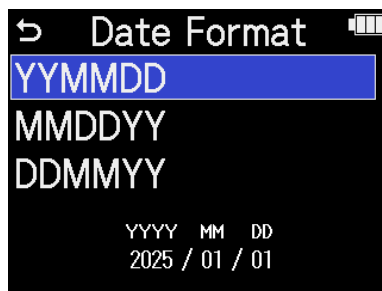

A specific example of the set date format will be shown at the bottom of the screen using the current date setting.



Setting value	Explanation
YYMMDD	The date is shown in year, month, day order.
MMDDYY	The date is shown in month, day, year order.
DDMMYY	The date is shown in day, month, year order.

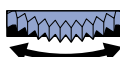

After the date format setting is confirmed, set the date and time when a screen to set them opens. (→ [Setting the date and time \(first time starting up\)](#))

HINT

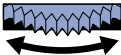

- The date format setting can also be changed later on the System Settings Screen. (→ [Setting the date format](#))
- Use the  (selection) dial to select  and press the  (ENTER) button to return to the previous setting screen.

Setting the date and time (first time starting up)

Set the date and time when a screen to set them is shown after setting the date format the first time the power is turned on after purchase or after the H5studio has been reset to factory defaults. The date and time are stored in recording files.

1. Use the  (selection) dial to select the desired item to set and press the  (ENTER) button.

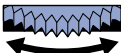

2. Use the  (selection) dial to change the value and press the  (ENTER) button.



3. Repeat steps 1-2 to set the date and time.

4. After setting all the items, use the  (selection) dial to select  and press the  (ENTER) button.





After the date and time setting is confirmed, set the battery type when a screen to set it opens.
(→ [Setting the type of batteries used \(first time starting up\)](#))

NOTE



If power is not supplied by an AC adapter or batteries for a long time, and the power supply for date and time retention becomes depleted, data stored in the unit will be reset.
If the Set Date/Time Screen appears during startup, set them again.

HINT

- The date and time settings can also be changed later on the System Settings Screen. (→ [Setting the date and time](#))
 - Use the  (selection) dial to select  and press the  (ENTER) button to return to the previous setting screen.
-

Setting the type of batteries used (first time starting up)

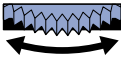
Set the type of batteries used in the H5studio when a screen to set it is shown after setting the date and time the first time the power is turned on after purchase or after the H5studio has been reset to factory defaults. This is necessary to accurately show the remaining battery charge on the screen.

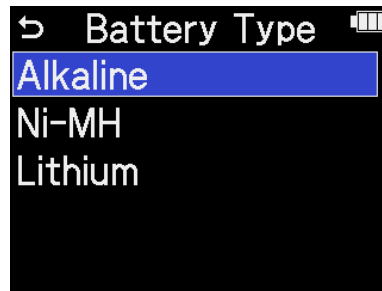

1. Use the  (selection) dial to select the battery type and press the  (ENTER) button.



Setting value	Explanation
Alkaline	Alkaline batteries
Ni-MH	Nickel-metal hydride batteries
Lithium	Lithium batteries

After first-time settings are complete, the [Home Screen](#) will open.

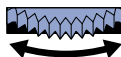
HINT

- The battery type setting can be changed later on the Setting Screen. (→ [Setting the type of batteries used](#))
- Use the  (selection) dial to select  and press the  (ENTER) button to return to the previous setting screen.

Preventing misoperation (HOLD function)

In order to prevent misoperation, the hold function can be used to disable the buttons on the H5studio.

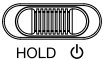
1. Slide the  (POWER/HOLD) switch toward "HOLD" (toward the mic capsule).

This turns on the HOLD function, disabling operations using all buttons.

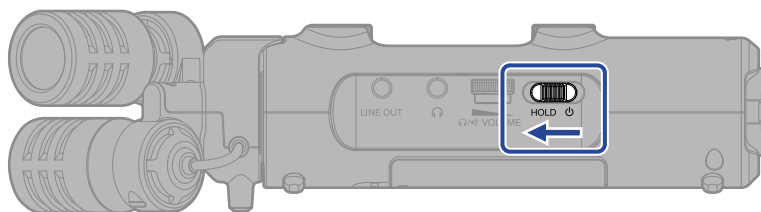

To deactivate the HOLD function, slide the  (POWER/HOLD) switch back to the center position.

NOTE

The volume can be adjusted using the

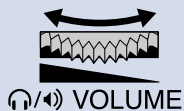

(VOLUME) dial even when the hold function is on.

Making input settings

Enabling tracks for recording

Select which of the MIC (mic capsule) and INPUT 1–2 tracks to record.

1. When the [Home Screen](#) is open, press the buttons of the tracks that you want to record. The status indicators for selected tracks will light red.

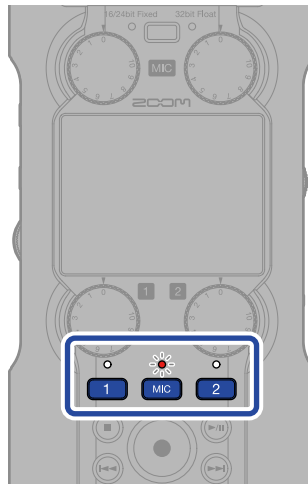



- **MIC** : Mic capsule
- **1** , **2** : INPUT 1 and 2

NOTE

When tracks are stereo-linked, either of their buttons can be pressed to select both.

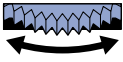

Converting mic capsule input to mono

Mic capsule input can be mixed to a single channel and handled as mono audio.

1. On the [Home Screen](#), use the  (selection) dial to select  (INPUT) and press the  (ENTER) button.
This opens the [Input Settings Screen](#).

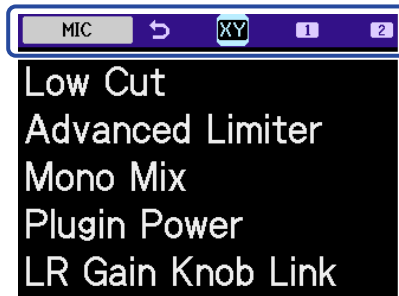
2. Use the  (selection) dial to select  (MIC) and press the  (ENTER) button.

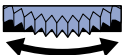

3. Use the  (selection) dial to select "Mono Mix" and press the  (ENTER) button.

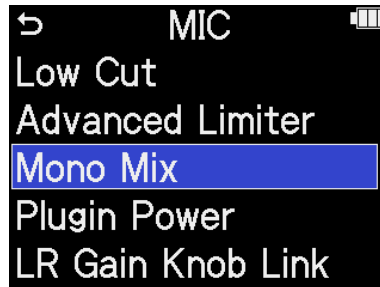

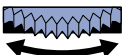
4. Use the  (selection) dial to select "On" or "Off" and press the  (ENTER) button.

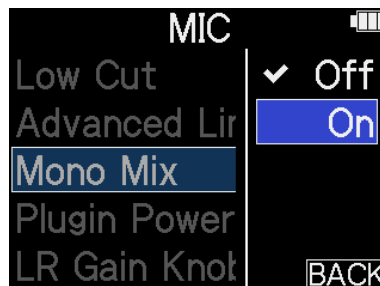

When "On" is selected, mic capsule input will become mono.



NOTE

The recording file format will be changed in the same way. (→ [Folder and file structure](#))

- Set to "On": mono files
- Set to "Off": stereo files
- The sound output from the Headphone and LINE OUT jacks and the sound during audio interface operation is also switched.

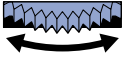

Using plug-in power

Make the following setting when a mic that is compatible with plug-in power is connected to the MIC/LINE IN jack.

1. On the [Home Screen](#), use the  (selection) dial to select  (INPUT) and press the  (ENTER) button.
This opens the [Input Settings Screen](#).

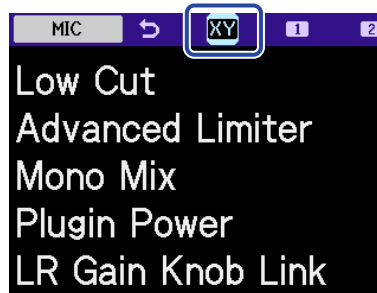
2. Use the  (selection) dial to select  (MIC) and press the  (ENTER) button.

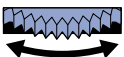

3. Use the  (selection) dial to select "Plugin Power" and press the  (ENTER) button.

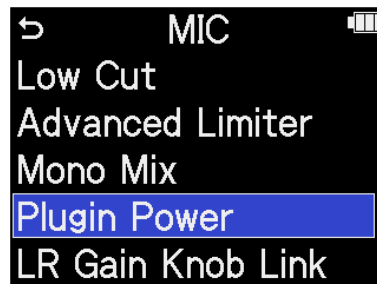

4. Use the  (selection) dial to select "On" and press the  (ENTER) button.

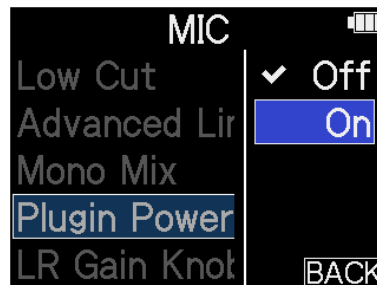





NOTE

This setting can be set only when a mic capsule that can provide plug-in power is connected.

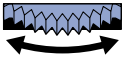
Setting the input level (mic/line)

The input level can be set according to the devices connected to the H5studio INPUT 1 and 2.

1. On the [Home Screen](#), use the  (selection) dial to select  (INPUT) and press the  (ENTER) button.
This opens the [Input Settings Screen](#).

2. Use the  (selection) dial to select the input for level setting and press the  (ENTER) button.

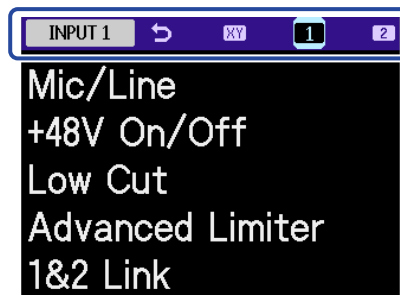

3. Use the  (selection) dial to select "Mic/Line" and press the  (ENTER) button.

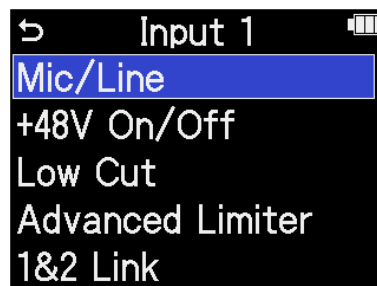

4. Use the  (selection) dial to select "Mic" or "Line" and press the  (ENTER) button.

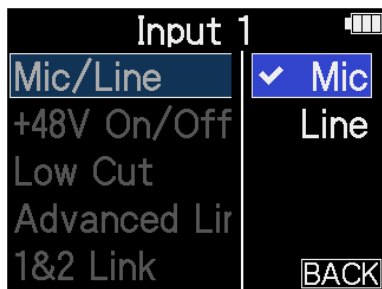



Setting	Explanation
Mic	Use when connecting a mic or other equipment with a low input level.
Line	Use when connecting line level equipment. The input level will be reduced 20 dB compared to when "Mic" is selected.



Setting phantom power

H5studio INPUT 1 and 2 support phantom power and can provide +48 V. Turn on phantom power when condenser mics that require it are connected.

This can be turned on/off separately for each input.

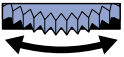

1. On the [Home Screen](#), use the  (selection) dial to select  (INPUT) and press the  (ENTER) button.

This opens the [Input Settings Screen](#).

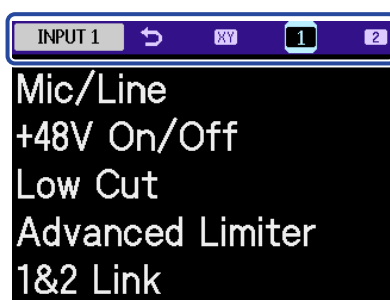

2. Use the  (selection) dial to select the input for phantom power setting and press the  (ENTER) button.

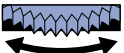

-  ,  : INPUT 1 and 2

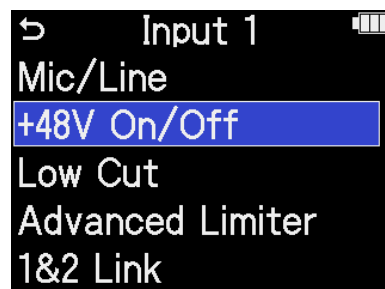
3. Use the  (selection) dial to select "+48V On/Off" and press the  (ENTER) button.



4. Use the  (selection) dial to select "On" or "Off" and press the  (ENTER) button.

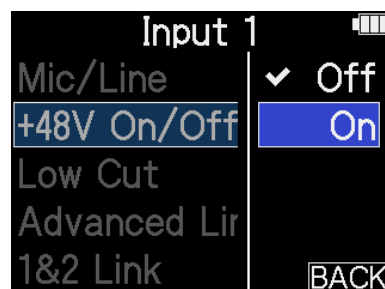

NOTE

When connecting devices that are not compatible with phantom power, do not turn on the phantom setting. Doing so could damage those devices.



HINT



Phantom power is a function that supplies power to devices that require an external power supply, including some condenser mics.

+48 V is common.

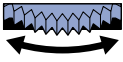

Reducing noise (Low Cut)

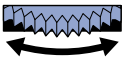
Low frequencies can be cut to reduce the sound of wind and vocal pop noises, for example.

1. On the [Home Screen](#), use the  (selection) dial to select  (INPUT) and press the  (ENTER) button.
This opens the [Input Settings Screen](#).

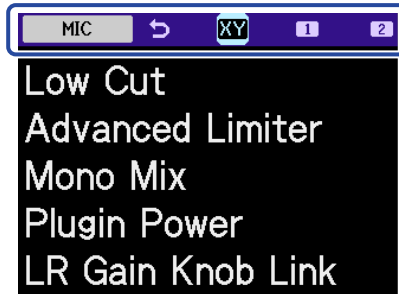

2. Use the  (selection) dial to select the input for low cut setting and press the  (ENTER) button.



-  : MIC (mic capsule)
-  ,  : INPUT 1 and 2

3. Use the  (selection) dial to select "Low Cut" and press the  (ENTER) button.

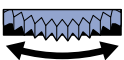

4. Use the  (selection) dial to select the cut frequency and press the  (ENTER) button.

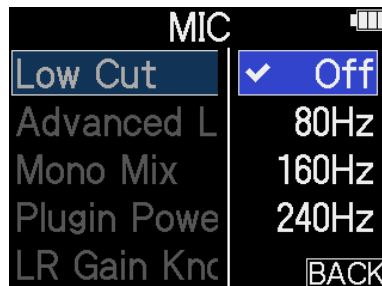





Low Cut can be set to Off, 80 Hz, 160 Hz or 240 Hz.

Setting the Advanced Limiter

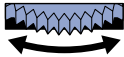

This limiter can be turned on/off on each track.

The H5studio limiter can be set to detect the maximum level in advance and is optimized to prevent distortion.

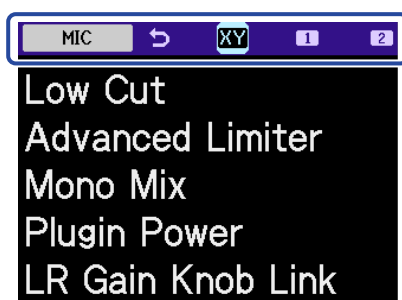

1. On the [Home Screen](#), use the  (selection) dial to select  (INPUT) and press the  (ENTER) button.
This opens the [Input Settings Screen](#).

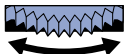
2. Use the  (selection) dial to select the input for Advanced Limiter setting and press the  (ENTER) button.

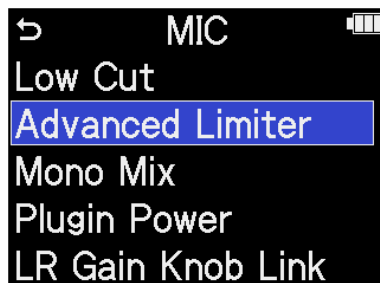

3. Use the  (selection) dial to select "Advanced Limiter" and press the  (ENTER) button.

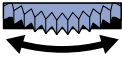

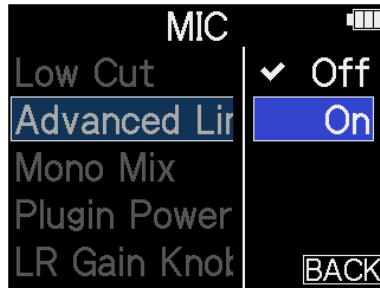

4. Use the  (selection) dial to select "On" or "Off" and press the  (ENTER) button.

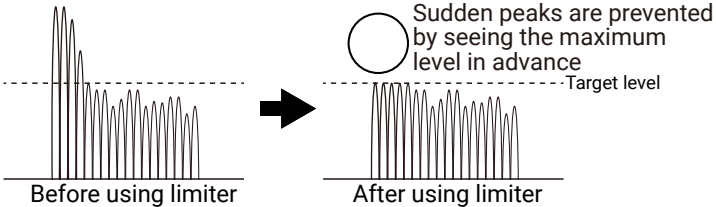



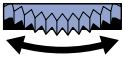

Setting value	Explanation
Off	This disables the limiter.
On	<p>This limiter is optimized to prevent distortion by detecting the maximum level in advance.</p> <p>The ratio is ∞:1, providing increased internal headroom.</p> <div style="text-align: center;">  <p>The diagram illustrates the effect of the limiter. On the left, a waveform labeled 'Before using limiter' shows a series of peaks that exceed a dashed horizontal line representing the 'Target level'. On the right, a waveform labeled 'After using limiter' shows the same series of peaks, but the highest ones are flattened to meet the 'Target level'. A circle highlights the top of the waveform in the 'After' state, with a callout stating: 'Sudden peaks are prevented by seeing the maximum level in advance'. An arrow points from the 'Before' state to the 'After' state.</p> </div>

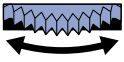

Enabling stereo linking

Using stereo-linking, input signals from INPUT 1 and 2 can be handled as stereo audio.

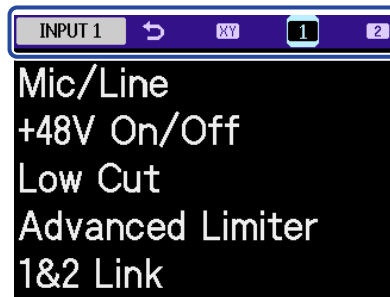

1. On the [Home Screen](#), use the  (selection) dial to select  (INPUT) and press the  (ENTER) button.
This opens the [Input Settings Screen](#).

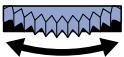
2. Use the  (selection) dial to select an input to stereo link ( or ) and press the  (ENTER) button.

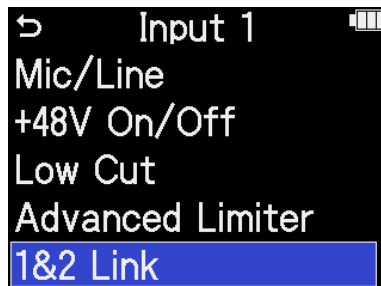

3. Use the  (selection) dial to select "1&2 Link" and press the  (ENTER) button.

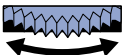

4. Use the  (selection) dial to select the desired item to set and press the  (ENTER) button.

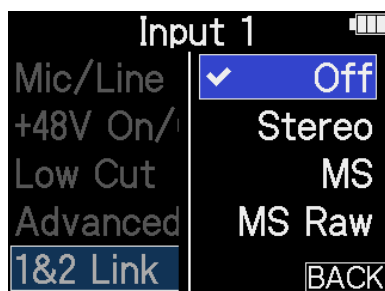

Setting value	Explanation
Off	Input signals will be handled as mono audio.
Stereo	The input signals from INPUT 1 and 2 will be handled as a stereo audio signal. INPUT 1 will become the L channel and INPUT 2 will become the R channel.
MS	The input signals from inputs 1 and 2 will be handled as stereo audio captured in mid-side format. Audio will be recorded using mid-side processing with INPUT 1 as the mid and INPUT 2 as the side.
MS Raw	The input signals from inputs 1 and 2 will be handled as stereo audio captured in mid-side format. Mid audio and side audio will be recorded separately as left and right channels in a stereo file before mid-side processing. This setting is useful for changing the side level during post-production after recording.

HINT

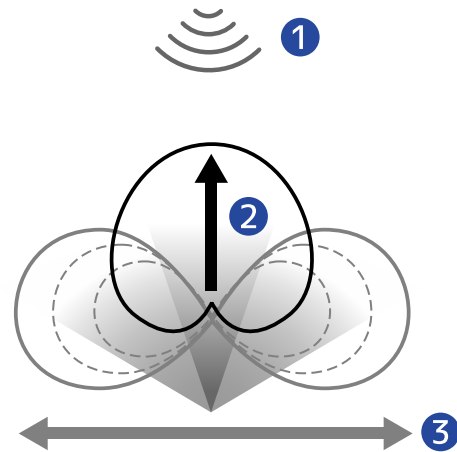

- Mid-side format is a recording method comprised of a mid mic and a side mic.
- The mid mic captures sound front and center while the side mic captures sound to the left and right. These signals are recorded and converted to stereo. At this time, the stereo width can be changed by altering the side mic recording level.
- Use the  (GAIN) knob for each track to adjust the mid/side balance.
Use the INPUT 1 GAIN knob to adjust the mid and the INPUT 2 GAIN knob to adjust the side.
Before doing this, set 1&2 Gain Knob Link to Off. (→ [Linking gain knobs](#))





- 1 Sound source
- 2 Mid mic
- 3 Side mic

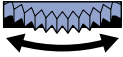

Linking gain knobs

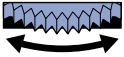
On the H5studio, the gain controls can be set to be linked for the L and R channels of the mic capsule as well as for INPUT 1 and INPUT 2.

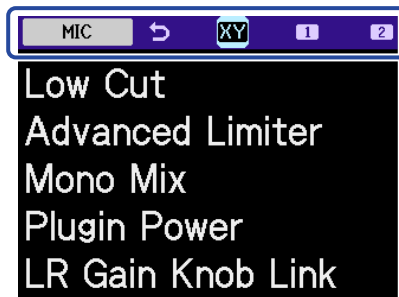

1. On the [Home Screen](#), use the  (selection) dial to select  (INPUT) and press the  (ENTER) button.
This opens the [Input Settings Screen](#).

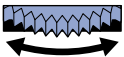
2. Use the  (selection) dial to select an input for gain knob linking and press the  (ENTER) button.

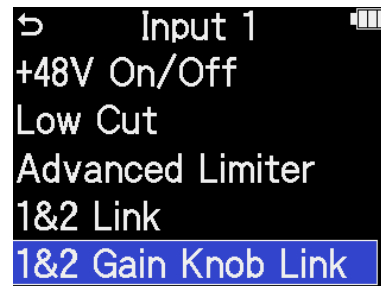

3. Use the  (selection) dial to select "LR Gain Knob Link" or "1&2 Gain Knob Link" and press the  (ENTER) button.

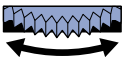

4. Use the  (selection) dial to select "On" or "Off" and press the  (ENTER) button.

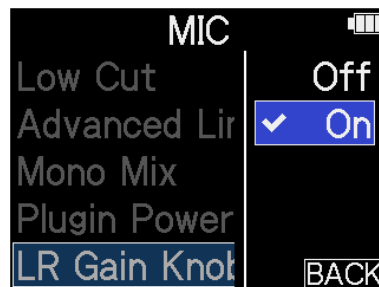



Setting value	Explanation
Off	<p>Gain will not be linked for mic capsule L and R channels or for INPUT 1 and INPUT 2.</p> <ul style="list-style-type: none"> • Mic capsule The left MIC GAIN knob adjusts the gain for the L channel and the right MIC GAIN knob adjusts the gain for the R channel. • INPUT 1 and 2 The INPUT 1 GAIN knob adjusts the gain for INPUT 1 and the INPUT 2 GAIN knob adjusts the gain for INPUT 2.
On	<p>Gain will be linked for mic capsule L and R channels or for INPUT 1 and INPUT 2.</p> <ul style="list-style-type: none"> • Mic capsule The gain set with the left MIC GAIN knob is applied to both the L and R channels. • INPUT 1 and 2 The gain set with the INPUT 1 GAIN knob is applied to both INPUT 1 and INPUT 2.

Adjusting input gain

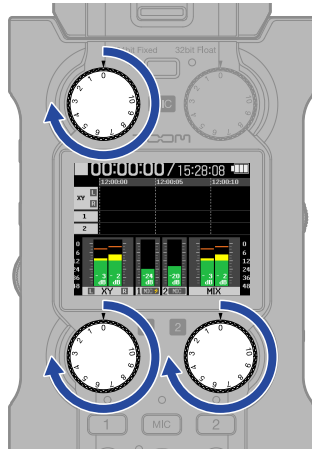
Use the  (GAIN) knobs for each track on the H5studio to adjust their input gains.



NOTE

- Adjusting levels with the  (GAIN) knobs will affect the monitored sound and the recording data.
- When the recording mode is "16/24-bit Fixed", adjust them so that the level meters are around -12 dB at maximum volume. Clipping indicators will light if recording levels reach 0 dB.
- The  (GAIN) knobs can be used even while recording to adjust levels.

Making output settings

Adjusting the line output level



The line level output to other devices can be adjusted.

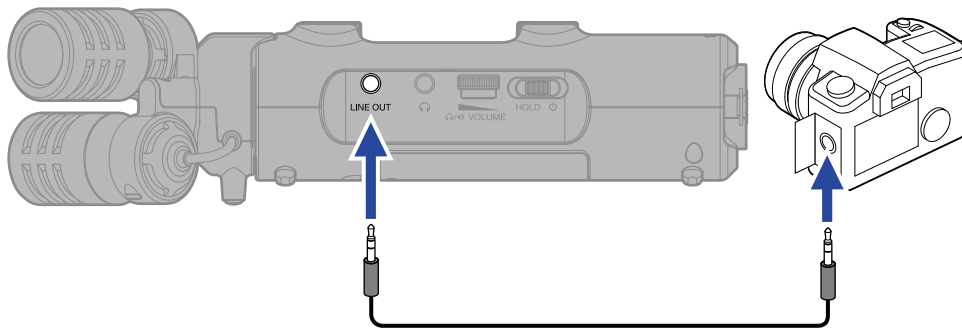

1. Minimize the input gain of the other device.
2. Use an audio cable to connect the external mic jack of the other device with the H5studio LINE OUT jack.



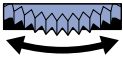

HINT

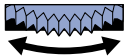
When output to an external device is unnecessary, disconnecting the cable from the LINE OUT jack can increase the amount of operation time when using batteries.

3. On the [Home Screen](#), use the  (selection) dial to select  (OUTPUT) and press the  (ENTER) button.
This opens the Output Settings Screen.

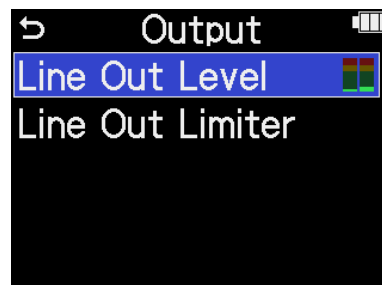
4. Use the  (selection) dial to select "Line Out Level" and press the  (ENTER) button.



5. Use the  (selection) dial to adjust the line output level and press the  (ENTER) button. The output level meters can be checked while adjusting.

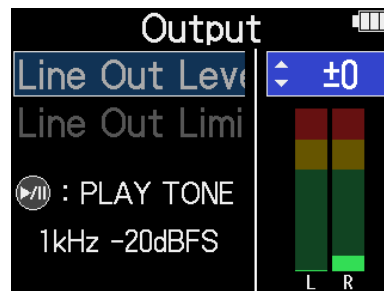

HINT

- This can be set to “Mute” or from –40 to +40.
 - Selecting “Mute” silences the output from the LINE OUT jack.
-

6. To output a test tone from the H5studio and adjust the output level, press . While checking the audio level meter of the connected device, adjust the input gain of that device until the audio signal level is about –20 dB.

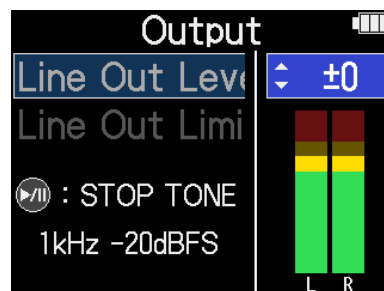

HINT

The test tone is a 1kHz sine wave at –20 dBFS.



7. After adjusting the input gain of the connected device, press the  (ENTER) button. This stops test tone output.

NOTE

- See the manual of the connected device for information about its operation.
- If the automatic gain control function on the other device is on, turn it off.
- The level adjusted here does not affect the recorded audio or the audio levels output from the headphone jack or the USB port.

Using a limiter on the line output

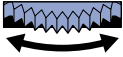
The line output limiter can be used to reduce signals with levels that are too high, protecting the device connected to the line output jack.

1. On the [Home Screen](#), use the  (selection) dial to select  (OUTPUT) and press the  (ENTER) button.
This opens the Output Settings Screen.

2. Use the  (selection) dial to select "Line Out Limiter" and press the  (ENTER) button.

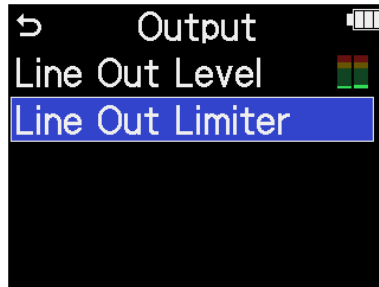

3. Use the  (selection) dial to select "On" and press the  (ENTER) button.

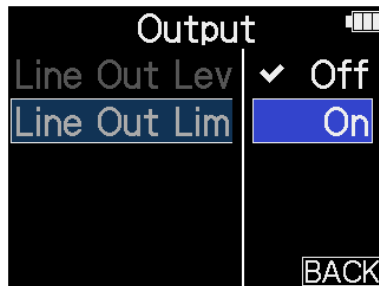

Recording

When recording with the H5studio, every selected track is recorded separately. In addition, all signals can be mixed to stereo and simultaneously recorded as a stereo file.

This stereo file is recorded with the mix of levels adjusted using the  (GAIN) knobs. (→ [Adjusting the overall level balance](#))

NOTE

- Stereo files might not be created depending on the setting. (→ [Setting whether to record mix files](#))
- The recorder can be set to not record mixed stereo files. (→ [Setting whether to record mix files](#))
- For details about recorded files, see "[H5studio folder and file structure](#)".

Monitoring input sounds

Use headphones, for example, to monitor input sounds and adjust levels.

1. Connect headphones, for example, to the PHONE/LINE OUT jack.

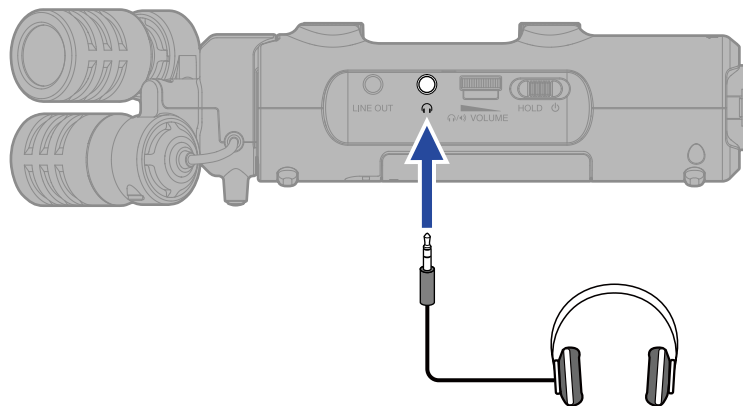

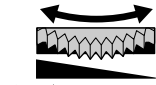
2. Use the  (VOLUME) dial to adjust the volume for the headphones or other connected device.

The volume is shown on the display while the volume is being adjusted.

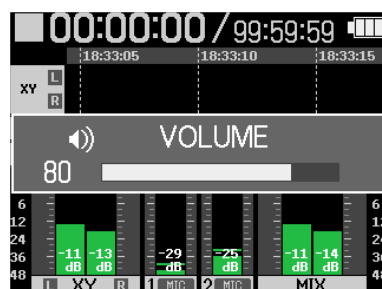

NOTE

- The volume output from the headphone jack is also affected by level adjustments made using the GAIN knobs. Adjust the headphone volume after adjusting the input mix levels. (→ [Adjusting the overall level balance](#))
- The built-in speaker cannot be used for monitoring while recording.

HINT



- When monitoring with headphones is unnecessary, disconnecting the headphones from the headphone jack can increase the length of battery operation time.
- The level of each input can also be adjusted separately. (→ [Adjusting the overall level balance](#))

Adjusting the overall level balance

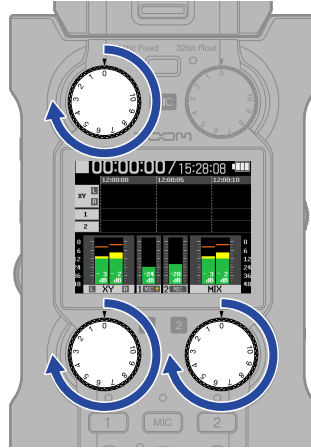
Using the H5studio  (GAIN) knobs, the levels of each input and the stereo mix can be adjusted to balance the overall level.



NOTE

- Adjusting levels with the  (GAIN) knobs will affect the monitored sound and the recording data.
- When the recording mode is “16/24-bit Fixed”, adjust them so that the level meters are around -12 dB at maximum volume. Clipping indicators will light if recording levels reach 0 dB.
- The  (GAIN) knobs can be used even while recording to adjust levels.

Making recording settings

Setting the recording mode

The H5studio allows selection 16/24-bit fixed or 32-bit float formats for recording files.

1. Press the  (Recording Mode) button on the H5studio.

2. Select "Change to Fixed" or "Change to Float".

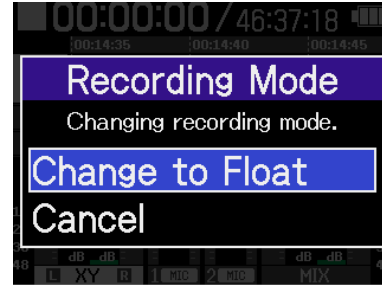

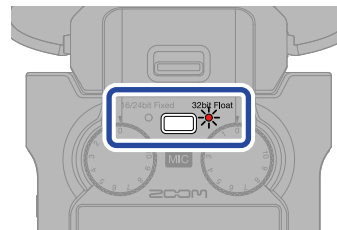
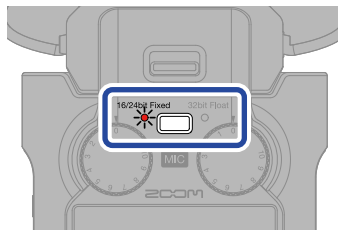

3. Confirm that the indicator for the desired setting value is lit.





Setting value	Explanation
32bit Float	Audio files will not be clipped.
16/24bit Fixed	The data size of recorded files will be smaller, but recording levels must be adjusted to prevent clipping. (→ Adjusting input gain)

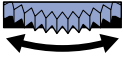

Setting the sample rate

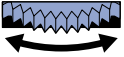
The sample rate used to record files can be set.

1. On the [Home Screen](#), use the  (selection) dial to select  (REC) and press the  (ENTER) button.
This opens the Rec Settings Screen.

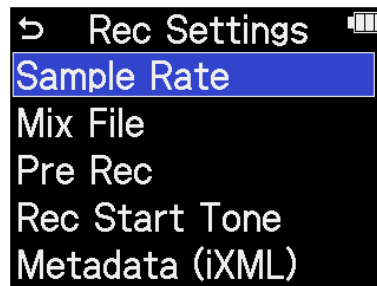
2. Use the  (selection) dial to select "Sample Rate" and press the  (ENTER) button to confirm.

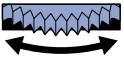

3. Use the  (selection) dial to select the sample rate and press the  (ENTER) button to confirm.

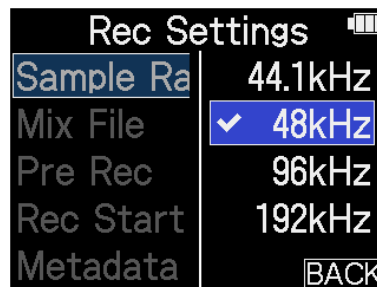



The following sample rates can be selected.

44.1 kHz, 48 kHz, 96 kHz, 192 kHz

Selecting the bit depth

The bit depth of recorded files can be set.



This can only be set when the recording mode is "16/24-bit Fixed". (→ [Setting the recording mode](#))

1. On the [Home Screen](#), use the  (selection) dial to select  (REC) and press the  (ENTER) button.

This opens the Rec Settings Screen.

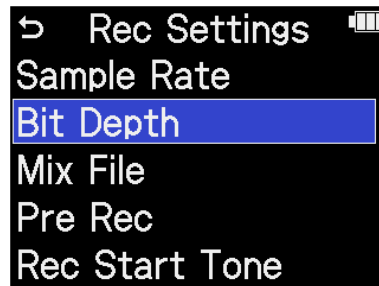
2. Use the  (selection) dial to select "Bit Depth" and press the  (ENTER) button.



3. Use the  (selection) dial to select the bit depth and press the  (ENTER) button to confirm.

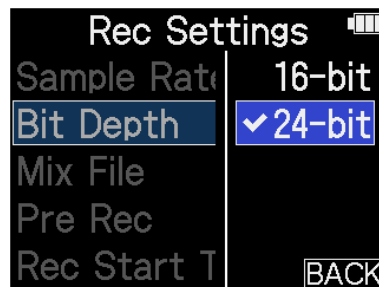

The following bit depths can be selected.

16-bit, 24-bit

NOTE

When the recording mode is "32-bit Float", the bit depth is always 32-bit float.



Setting whether to record mix files



In addition to recording each track separately, the H5studio can also record a stereo mix file of those tracks.

The recording of stereo mix files can be disabled to save SD card space.

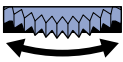
NOTE

- Even when mix file recording is on, mix files will not be recorded in the following cases.
 - When the sampling rate is 192 kHz.
 - When only one file would otherwise be created (for example, when only one track or a stereo-linked pair of tracks is being recorded)
- Use the export function to create a mixed 192kHz stereo file. (→ [Changing the file format and exporting files](#))

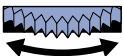

1. On the [Home Screen](#), use the  (selection) dial to select  (REC) and press the  (ENTER) button.
This opens the Rec Settings Screen.

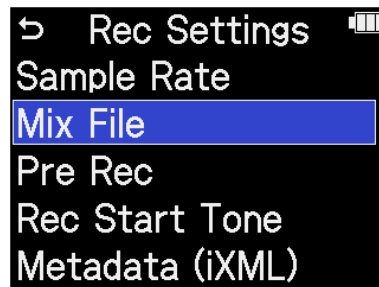
2. Use the  (selection) dial to select "Mix File" and press the  (ENTER) button.

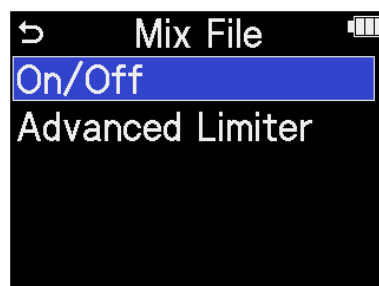

3. Use the  (selection) dial to select "On/Off" and press the  (ENTER) button.

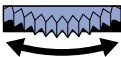

4. Use the  (selection) dial to select "On" or "Off" and press the  (ENTER) button to confirm.

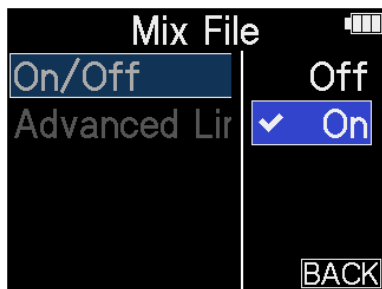



Setting value	Explanation
Off	Stereo mix files will not be recorded.
On	Stereo mix files will be recorded.

Setting the Advanced Limiter for mix files

This limiter can be turned on/off for mix files.



The H5studio limiter can be set to detect the maximum level in advance and is optimized to prevent distortion.

1. On the [Home Screen](#), use the  (selection) dial to select  (REC) and press the  (ENTER) button.

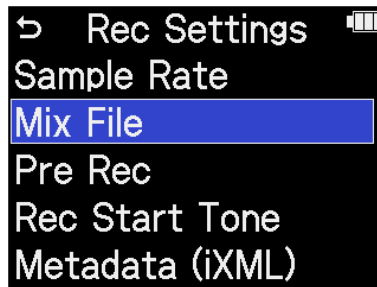

This opens the Rec Settings Screen.

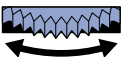
2. Use the  (selection) dial to select "Mix File" and press the  (ENTER) button.

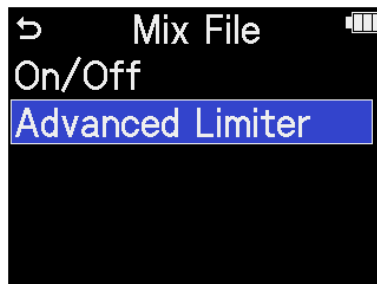

3. Use the  (selection) dial to select "Advanced Limiter" and press the  (ENTER) button.

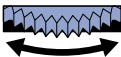

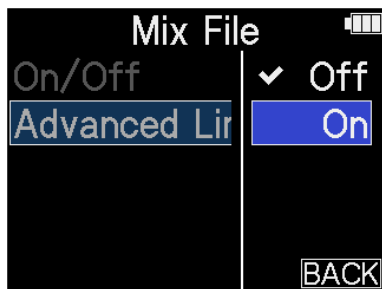

4. Use the  (selection) dial to select "On" or "Off" and press the  (ENTER) button to confirm.

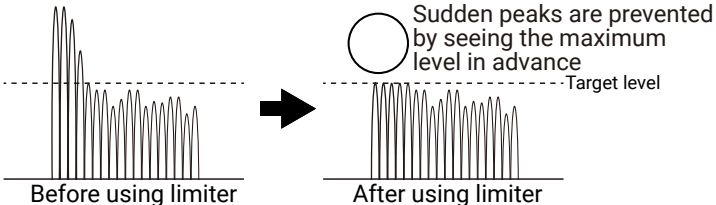



Setting value	Explanation
Off	This disables the limiter.
On	<p>This limiter is optimized to prevent distortion by detecting the maximum level in advance.</p> <p>The ratio is $\infty:1$, providing increased internal headroom.</p> <div style="display: flex; align-items: center; justify-content: center;">  </div> <p>The diagram illustrates the effect of the limiter. On the left, labeled 'Before using limiter', a waveform shows a series of peaks that increase in amplitude until they reach a dashed horizontal line representing the 'Target level'. On the right, labeled 'After using limiter', the same waveform is shown, but the peaks that would have exceeded the target level are now flattened to meet the target level. A circle highlights the top of these flattened peaks with the text 'Sudden peaks are prevented by seeing the maximum level in advance'. A dashed line labeled 'Target level' is shown in both parts of the diagram.</p>

Capturing audio before recording starts (pre-recording)

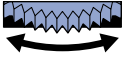

The input signal is always buffered for a set amount of time, so it can be captured (pre-recorded) for up to 6 seconds before the time when the  (REC) button is operated to start recording.

This is useful when the  (REC) button is operated late, for example.

1. On the [Home Screen](#), use the  (selection) dial to select  (REC) and press the  (ENTER) button.
This opens the Rec Settings Screen.

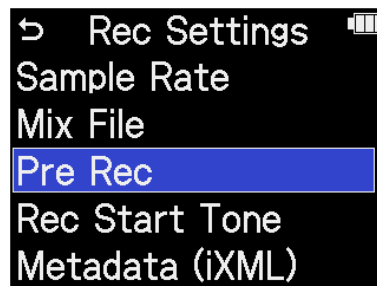
2. Use the  (selection) dial to select "Pre Rec" and press the  (ENTER) button to confirm.

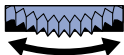

3. Use the  (selection) dial to select "On" and press the  (ENTER) button to confirm.

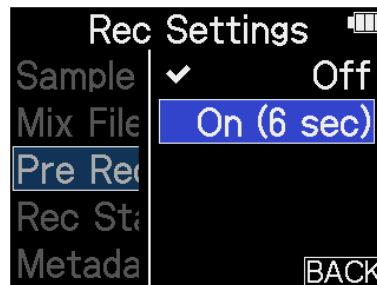



The amount of time that can be pre-recorded when this is set to "On" depends on the sample rate setting (→ [Setting the sample rate](#)).

Sample rate	Pre-recording time
44.1 kHz	6 seconds
48 kHz	6 seconds
96 kHz	3 seconds
192 kHz	1 second

Enabling the recording start tone

Half-second tone signals (recording start tones) can be output from the output jacks (headphone and LINE OUT jacks) when recording is started.

Since recording start tones are also written to recording files, when recording audio for video with the H5studio, sending its output signal to the camera input can make synchronizing audio and video easier.

1. On the [Home Screen](#), use the  (selection) dial to select  (REC) and press the  (ENTER) button.
This opens the Rec Settings Screen.

2. Use the  (selection) dial to select "Rec Start Tone" and press the  (ENTER) button to confirm.

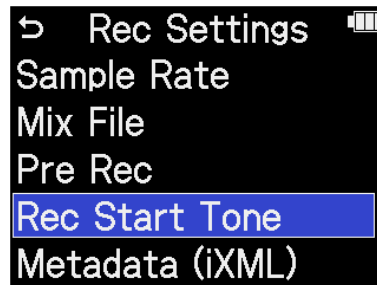

3. Use the  (selection) dial to select the recording start tone level and press the  (ENTER) button to confirm.

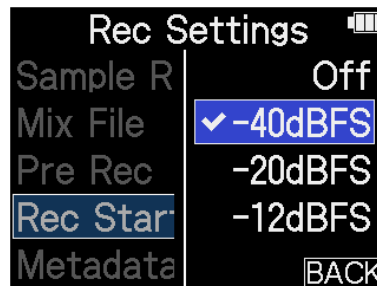

The following levels can be selected.

Off, -40 dBFS, -20 dBFS, -12 dBFS, -6 dBFS

No recording start tone will be played if "OFF" is selected.

4. Use a stereo mini jack cable to connect the input jack of the camera to the H5studio LINE OUT jack.

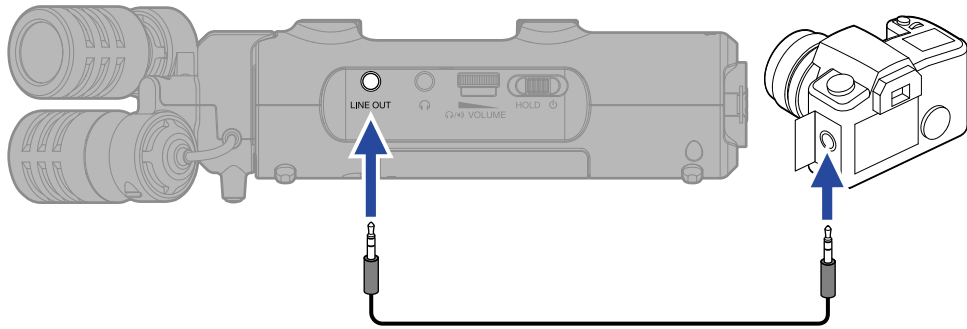





NOTE

Be careful with the volume if you are monitoring the input sound with headphones, for example.



Writing metadata (iXML chunks) to recording files

Various related information (metadata) stored in iXML chunks can be written to recorded files. (→ [Metadata contained in iXML chunks in WAV files](#))

1. On the [Home Screen](#), use the  (selection) dial to select  (REC) and press the  (ENTER) button.
This opens the Rec Settings Screen.

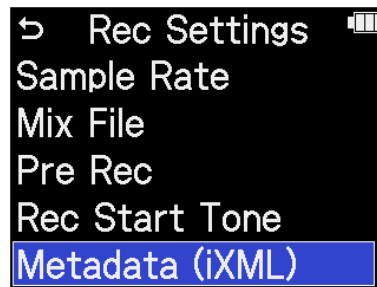
2. Use the  (selection) dial to select "Metadata (iXML)" and press the  (ENTER) button to confirm.

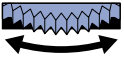

3. Use the  (selection) dial to select "Write" or "Off" and press the  (ENTER) button to confirm.

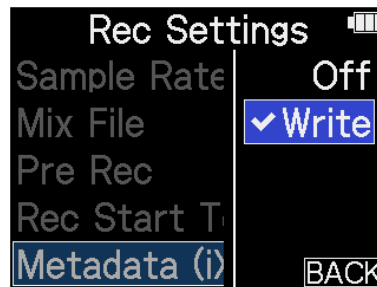



Setting value	Explanation
Off	Metadata (iXML chunks) will not be added to recording files.
Write	Metadata (iXML chunks) will be added to recording files.

NOTE

Some applications might not be compatible with files that have data embedded in them. If problems occur with files when using an application, turning off metadata writing might resolve them.

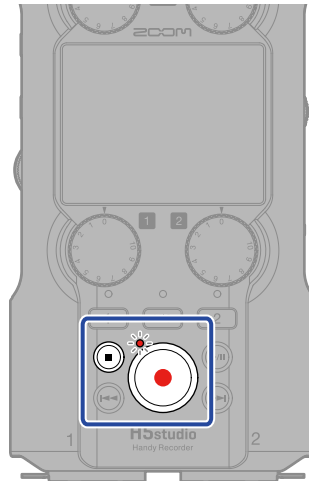
Recording



1. Press  when the Home Screen is open.

The REC indicator will light red, the name of the recording file will appear on the display and recording will start.

This shows the elapsed recording time when recording.

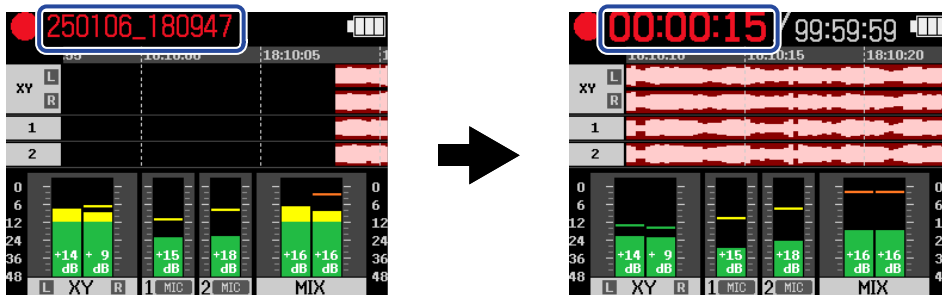

NOTE

The file name will be the date followed by the hour, minute and second using the set date and time ([Setting the date and time](#)). The date will be shown using numbers in the set order ([Setting the date format](#)). For details about file names, see "[Recording file names](#)".



2. To stop, press the  (REC) or  (STOP) button.

Slide the  (POWER/HOLD) switch toward HOLD (toward the mic capsule) to prevent misoperation while recording. (→ [Preventing misoperation \(HOLD function\)](#))

NOTE

If the file size exceeds 2 GB during recording, a new file will be created automatically and recording will continue without pause. No gap in sound will occur between the two files when this happens.

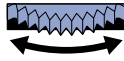
HINT

- Marks can be added while recording by using the  (selection) dial to select  (MARK) in the menu bar and pressing the  (ENTER) button. (→ [Adding marks during recording](#))
A maximum of 99 marks can be added in a file.
 - Files are automatically saved at regular intervals during recording. If the power is interrupted or another problem occurs during recording, an affected file can be restored to normal by playing it with the H5studio.
-

Pausing recording

By pausing recording and not recording unwanted intervals, microSD card capacity can be conserved.

1. Press the  (PLAY/PAUSE) button when recording.

This pauses recording.

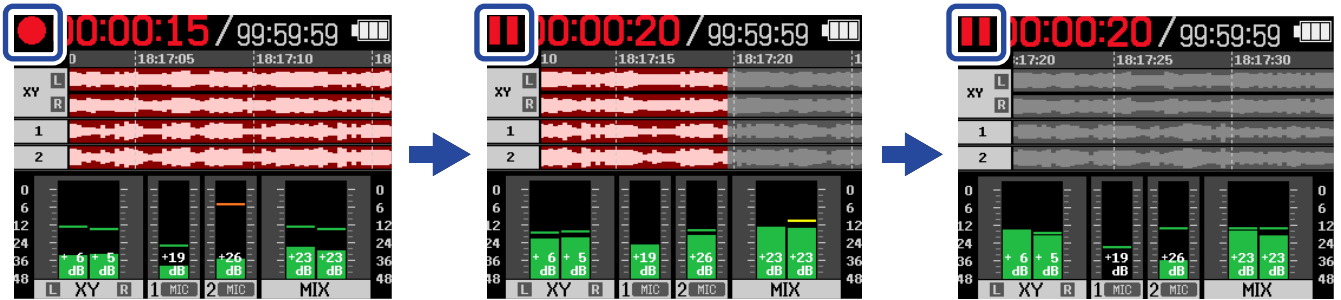



Press the  (PLAY/PAUSE) button again to resume recording.



NOTE

Resuming recording will automatically add a mark at that point.

Adding marks during recording

Marks can be added to files while recording.

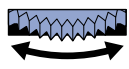
Added marks are shown on the [Playback Screen](#), and the  (REW) and  (FF) buttons can be used to move the playback position to marks.

1. While recording, use the  (selection) dial to select  (MARK) in the Menu bar and press the  (ENTER) button.

This will add a mark at the position of the current elapsed recording time.

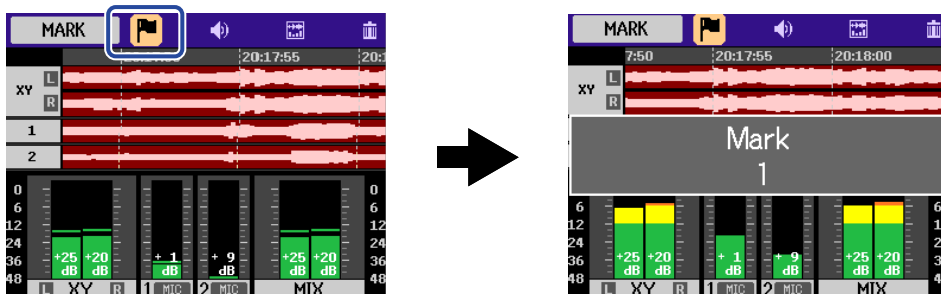



NOTE



A maximum of 99 marks can be added to a single file.

Moving the file being recorded to the TRASH folder

The file being recorded can be moved to the trash. This function is convenient when, for example, a recording was not good enough.

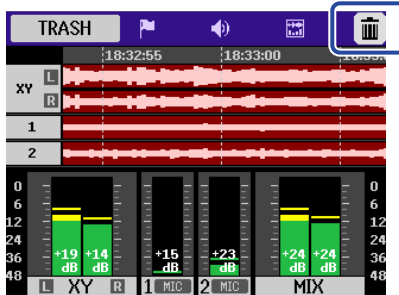
1. While recording, use the  (selection) dial to select  (TRASH) in the Menu bar and press the  (ENTER) button.

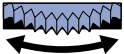

2. Use the  (selection) dial to select "Execute" and press the  (ENTER) button.

This will stop recording and move the file being recorded to the trash. (→ [H5studio folder and file structure](#))

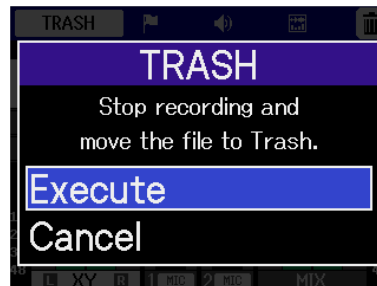

To cancel the operation and continue recording, select "Cancel" and press the  (ENTER) button.

NOTE

- Files moved to the trash are saved in the TRASH folder created on the SD card, but their information cannot be checked and they cannot be played back by the H5studio. To check or play them, connect and use a computer, smartphone or tablet. (→ [Transferring files to computers and other devices](#))
- The files in the trash can all be deleted at the same time. (→ [Deleting files in the TRASH folder](#))

Changing screen content

The Home Screen can be set to show level meters only, waveforms only or level meters and waveforms.

1. Use the  (selection) dial to select  (DISPLAY) and press the  (ENTER) button.

Press the  (ENTER) button to cycle through the following display options.

Level meters and waveforms

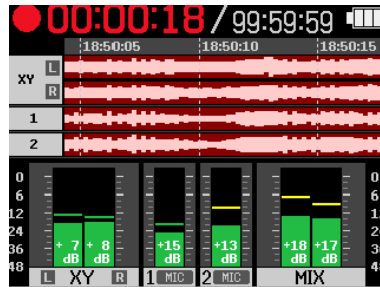

Waveforms only

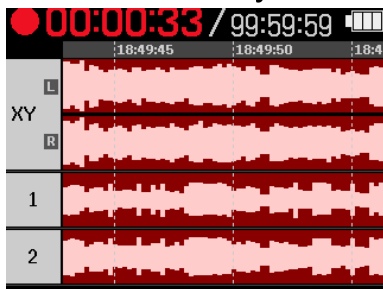

Level meters only

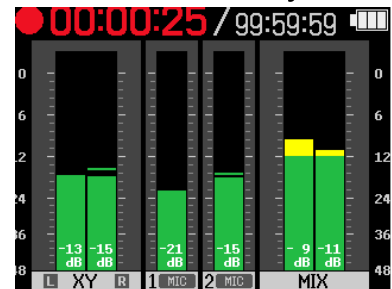

Playing recordings

Starting and stopping playback

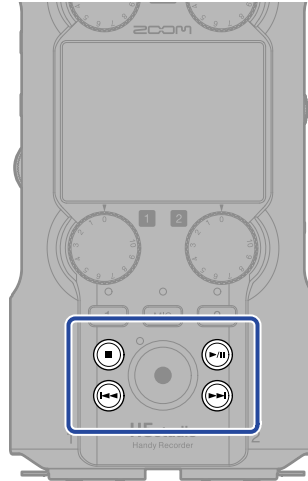

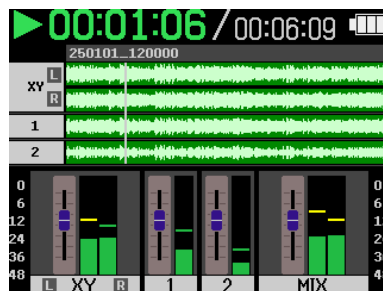

1. Press the  (PLAY/PAUSE) button when the [Home Screen](#) is open.

This opens the [Playback Screen](#) on the display and starts playback of the most recently recorded file.

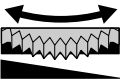

Use  to adjust the headphone or speaker volume. Levels can also be adjusted separately for each track. (→ [Adjusting the track level balance](#))

Use the  (REW) and  (FF) buttons to select the playback file.

When the Playback Screen is open, use the  (selection) dial to select a Menu bar icon and press the  (ENTER) button to open that settings screen. (→ [Playback Screen](#))



2. Press the (STOP) button.

This stops playback and reopens the [Home Screen](#).



NOTE

- On the Playback Screen, all the files in a file folder are treated as one file. For example, if two files named "240101_000000_Tr1.WAV" and "240101_000000_Tr2.WAV" have been created in a file folder, they will be shown as a single file named "240101_000000" on the File List Screen. If this file is selected and deleted, this operation will be applied to all files in the file folder. (→ [H5studio folder and file structure](#))
- Tracks that are off will not be used when exporting.

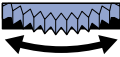

HINT

Track keys (, , ) can be pressed to turn on/off playback of those tracks. Tracks that have their status indicators lit will be played back. This operation is only possible with tracks that have been recorded.

Adjusting the track level balance

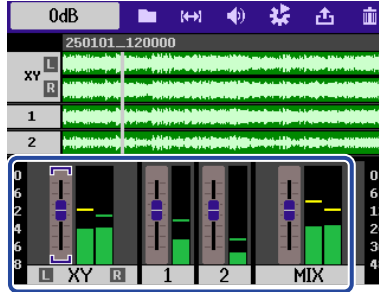
1. On the [Playback Screen](#), use the  (selection) dial to select the fader for the track desired for level adjustment and press the  (ENTER) button.

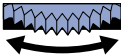

2. Use the  (selection) dial to change the level and press the  (ENTER) button.

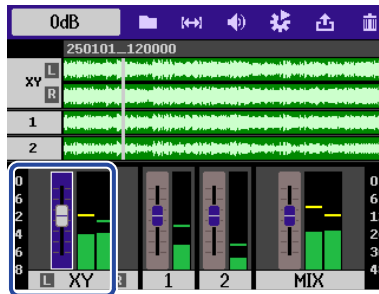



3. Repeat steps 1-2 to balance the levels overall.



NOTE

- Press the  (STOP) button to return to the [Home Screen](#).
- Level adjustments made on the Mixer Screen during playback can be applied to files created when exporting. (→ [Changing the file format and exporting files](#))

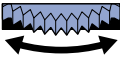

Setting repeat playback (Play Mode)

Playback can be set so that after one file completes the next file will be played without stopping.

1. On the [Playback Screen](#), use the  (selection) dial to select  (OPTION) and press the  (ENTER) button.

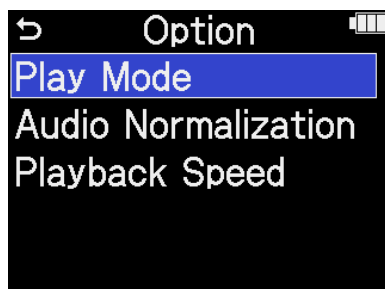
2. Use the  (selection) dial to select "Play Mode" and press the  (ENTER) button.

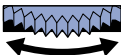

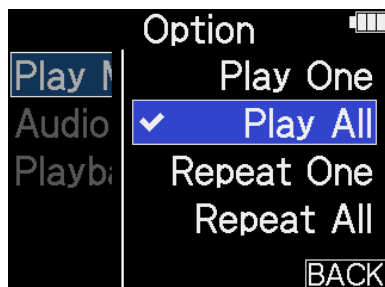

3. Use the  (selection) dial to select "Play Mode" and press the  (ENTER) button.



Setting value	Explanation
Play One	Playback stops after one file completes playing.
Play All	After one file completes playing, the next file plays back without stopping. Files will play in file name order. Playback will stop after the last file completes playing.
Repeat One	After one file completes playing, the same file will play again repeatedly.
Repeat All	After one file completes playing, the next file plays back without stopping. Files will play back in name order. After the last file completes, playback will continue from the first file.

Automatic volume adjustment during playback

By setting "Audio Normalization" to "On", the playback volume can be evened out regardless of recording levels.

1. On the [Playback Screen](#), use the  (selection) dial to select  (OUTPUT) and press the  (ENTER) button.
This opens the Output Settings Screen.

2. Use the  (selection) dial to select "Audio Normalization" and press the  (ENTER) button.

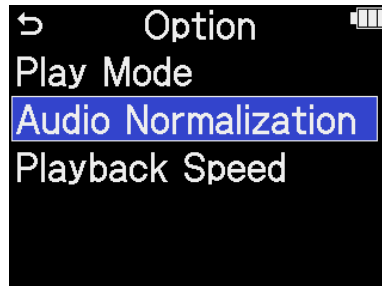



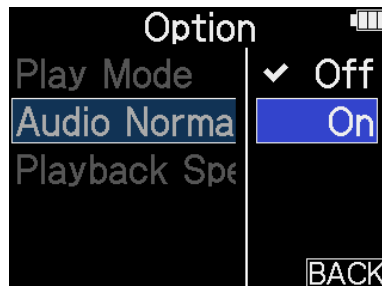

3. Use the  (selection) dial to select "On" and press the  (ENTER) button.



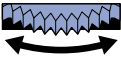

Changing the playback speed

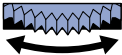
The playback speed can be changed.

1. On the [Playback Screen](#), use the  (selection) dial to select  (OUTPUT) and press the  (ENTER) button.
This opens the Output Settings Screen.

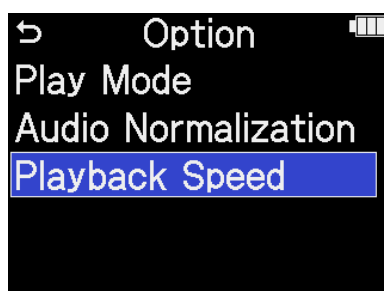
2. Use the  (selection) dial to select "Playback Speed" and press the  (ENTER) button.



3. Use the  (selection) dial to select the playback speed and press the  (ENTER) button.

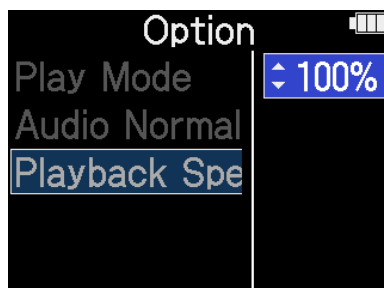



The following speeds can be selected.

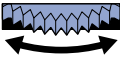

50% (half speed), 75%, 100% (normal), 125%, 150%, 200% (double speed)

Repeating playback of a set interval (A-B repeat)

Playback can be repeated between two set points.

1. On the [Playback Screen](#), use the  (selection) dial to select  (AB REPEAT) and press the  (ENTER) button.

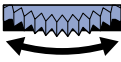

2. Use the  (selection) dial to select  (SET A) and press the  (ENTER) button.

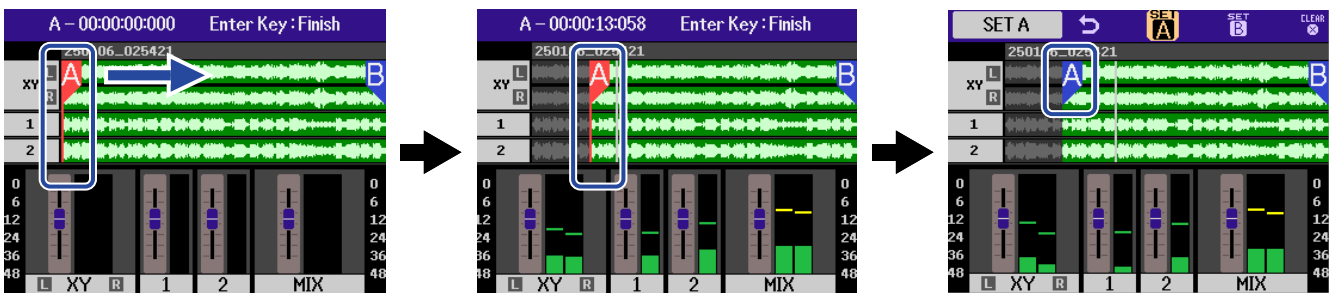
3. Use the  (selection) dial to set the A point (playback starting point) and press the  (ENTER) button.



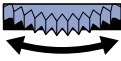

Pressing the  (ENTER) button confirms the A point and makes the A marker become blue.

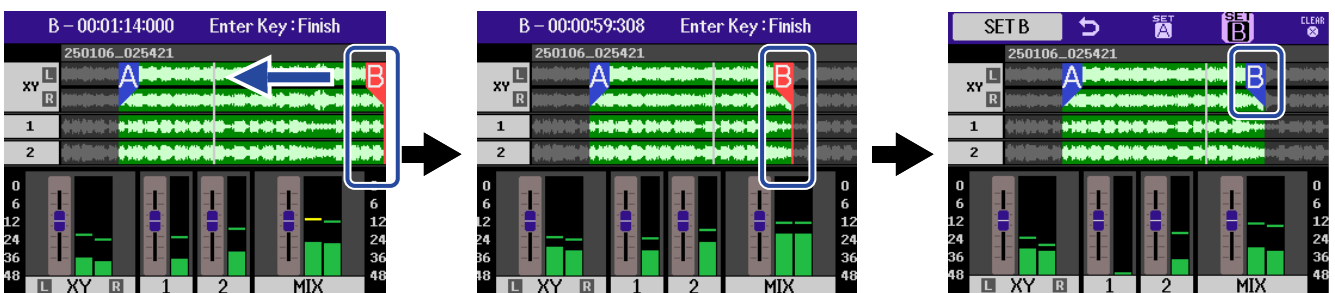

4. Use the  (selection) dial to select  (SET B) and press the  (ENTER) button.

5. Use the  (selection) dial to set the B point (playback ending point) and press the  (ENTER) button.

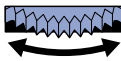

• To change these settings, repeat steps 2 – 4.

• Use the  (selection) dial to select  (CLEAR) and press the  (ENTER) button to clear the set points.

6. When done making settings, use the  (selection) dial to select  (BACK) and press the  (ENTER) button.

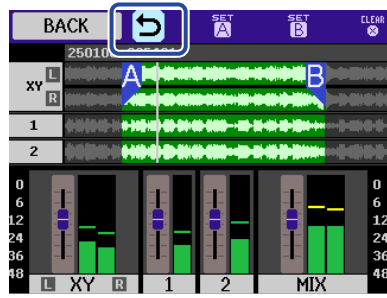

This reopens the [Playback Screen](#).

NOTE

- To cancel or change A-B repeat settings, press  (CLEAR) to reset the settings.
- The interval specified using the A-B Repeat function can be applied when exporting. (→ [Changing the file format and exporting files](#))

HINT



Since moving the A (playback start) and B (playback end) points during playback allows these positions to be changed in real time, they can be set while checking the playback sound.

Changing the file format and exporting files

The H5studio can convert and export recorded files in other formats.



This is convenient, for example, when loading files recorded on the H5studio to a computer, smartphone or tablet if the application being used does not support 32-bit float format.



In addition, the exported tracks can be selected and trimmed to only the necessary parts as well as normalized to optimize the volume of the recorded files.

1. On the [Playback Screen](#), use the  (selection) dial to select  (EXPORT) and press the  (ENTER) button.

This opens the Export Screen.

2. Select the bit depth.

Use the  (selection) dial to select "Bit Depth" and press the  (ENTER) button. Then, use

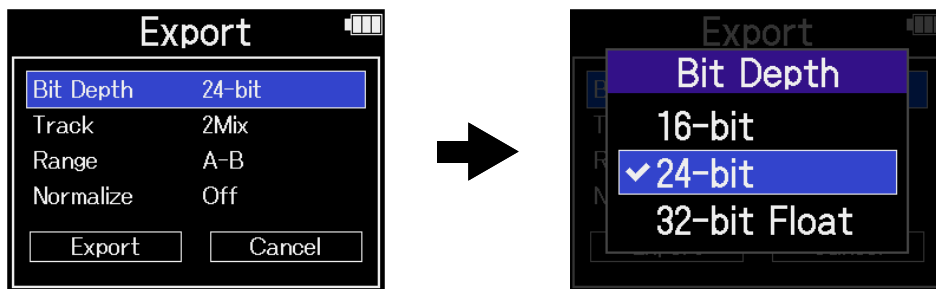

the  (selection) dial to select the format and press the  (ENTER) button.





The following formats can be selected.

16-bit, 24-bit, 32-bit Float

3. Select the tracks to export.



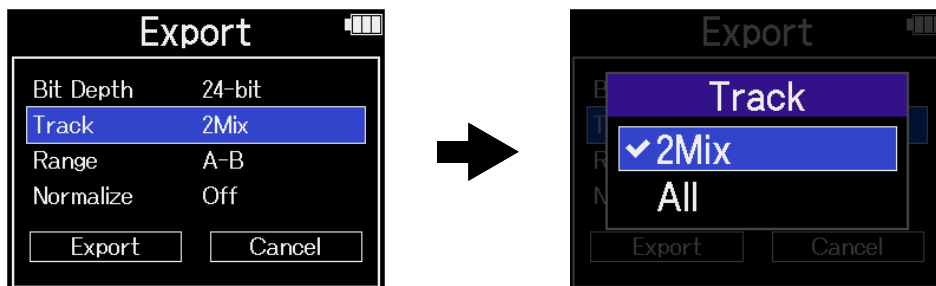

Use the  (selection) dial to select "Track" and press the  (ENTER) button. Then, use the

 (selection) dial to select the tracks to export and press the  (ENTER) button.



Setting value	Explanation
2Mix	This exports a stereo file that uses the mix adjusted with the mixer during playback. (→ Adjusting the track level balance)
All	This exports all the tracks separately.



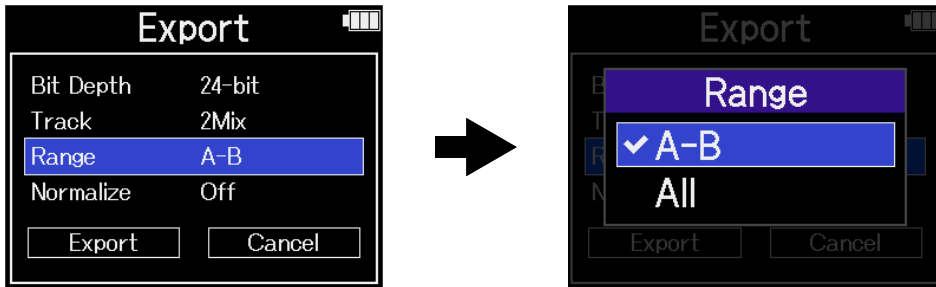

4. Select whether or not to export using a specified range.

Use the  (selection) dial to select "Range" and press the  (ENTER) button. Then, use the  (selection) dial to select the setting and press the  (ENTER) button.

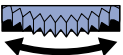

Setting value	Explanation
A-B	This exports the range between the two points set using Repeating playback of a set interval (A-B repeat) .
All	This exports the entire track.

5. Select whether or not to normalize.

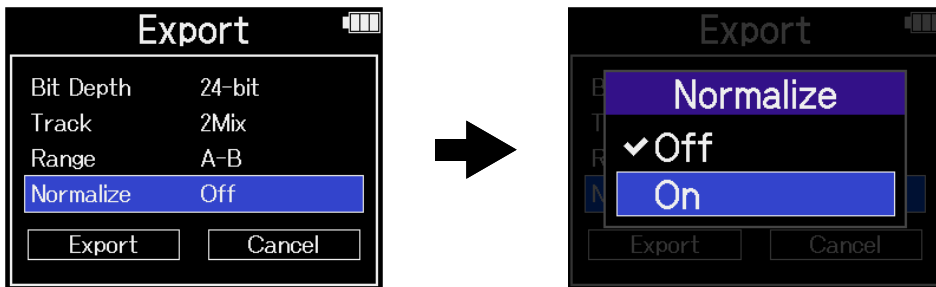

Use the  (selection) dial to select "Normalize" and press the  (ENTER) button. Then, use the  (selection) dial to select "On" or "Off" and press the  (ENTER) button.



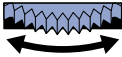

If "On" is selected, the file will be normalized during export.

NOTE

Normalization is a function that reads the maximum volume of the audio data and levels the volume without causing distortion. The volume is adjusted to the maximum possible without causing the loudest sound (peak) in the data to distort.

6. When done making all settings, use the  (selection) dial to select “Export” and press the  (ENTER) button.





7. Use the  (selection) dial to select “Execute” and press the  (ENTER) button.



The exported file will be saved in the Export folder. (→ [H5studio folder and file structure](#))

Select “Cancel” and press the  (ENTER) button to cancel the operation.

To cancel during an export, press the  (ENTER) button.



8. When “Done” appears after exporting finishes, press the  (ENTER) button.
This reopens the Playback Screen.

NOTE

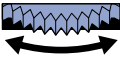

- Exported files saved in the Export folder are named in this format: FF_TT_BB_NN.WAV.
 - FF: Name of the file folder that holds the exported file
 - TT: Track name (used if “All” selected for “Tracks” / omitted if “Tracks” is “2Mix”)
 - BB: Bit depth (“16” when 16-bit selected, “24” when 24-bit selected or nothing when 32-bit float selected)
 - NN: Normalization setting (“NORM” when on or nothing when off)
- The H5studio cannot play files in the Export folder.

Moving the file being played to the TRASH folder

The file being played can be moved to the TRASH folder.

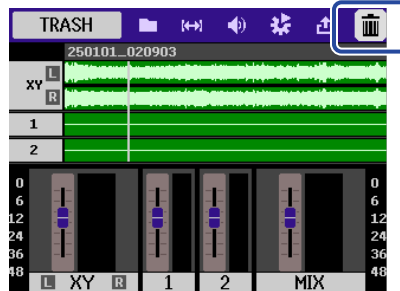
1. On the [Playback Screen](#), use the  (selection) dial to select  in the Menu bar and press the  (ENTER) button.

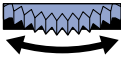

2. Use the  (selection) dial to select "Execute" and press the  (ENTER) button. This moves the file being played to the trash. (→ [H5studio folder and file structure](#))

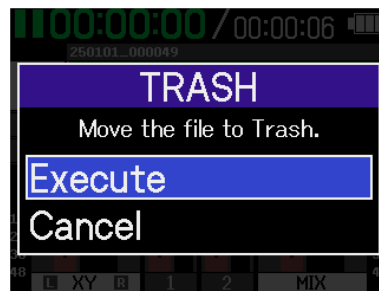

Select "Cancel" and press the  (ENTER) button to cancel the operation.

NOTE

- Files moved to the trash are saved in the TRASH folder, but their information cannot be checked and they cannot be played back by the H5studio. To check or play them, connect and use a computer, smartphone or tablet. (→ [Transferring files to computers and other devices](#))
- Be aware that all files in the file folder will be moved to the trash. (→ [H5studio folder and file structure](#))
- The files in the trash can all be deleted at the same time. (→ [Deleting files in the TRASH folder](#))

Managing files

Files created on the H5studio will be saved on the microSD card.
Recording files on the microSD card can be checked and deleted.

H5studio folder and file structure

Folder and file structure

When recording with the H5studio, files are created on microSD cards in the following manner.

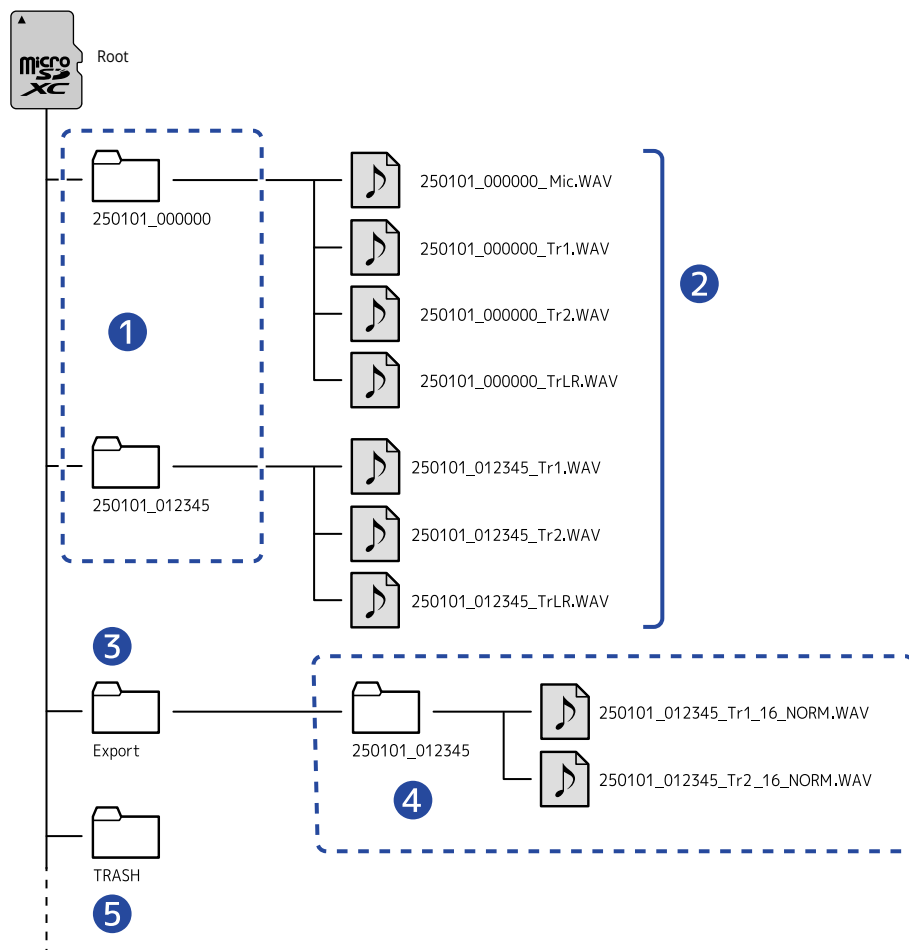

1 File folders

These are created each time recording is conducted. File folders are named in this format: Date_Time. The mono/stereo files created are saved in these.

2 Recording files

Files recorded by the H5studio are saved in file folders on the microSD card. For details about recording file names, see ["Recording file names"](#).

- Stereo files will be created if the MIC (mic capsule) “Mono Mix” setting is “Off” or if INPUT 1 and 2 are stereo linked. Mono files will be created in other cases. (→ [Converting mic capsule input to mono, Enabling stereo linking](#))

3 Export folder

These are created when files are exported. Files created by exporting are saved in the Export folder. (→ [Changing the file format and exporting files](#))

4 Exported files

Files created by exporting are saved in a subfolder with the same name inside the Export folder. (→ [Changing the file format and exporting files](#))

5 TRASH folder

The TRASH folder is created automatically when an SD card is loaded in the H5studio. Files that have been moved to the TRASH folder are saved inside it. (→ [Moving the file being recorded to the TRASH folder, Moving the file being played to the TRASH folder](#))

The files in the TRASH folder can all be deleted at the same time. (→ [Deleting files in the TRASH folder](#))

Recording file names

Files are named with the following format.

File name example	Explanation
<u>250101</u> _ <u>000000</u> _ <u>Tr1</u> .WAV 1 2 3	<ol style="list-style-type: none">1 Date The date of recording is used as a number. The numbers follow the set order (Setting the date format).2 Time The hour, minute and second are used as a number.3 Track name This shows the track used for recording.<ul style="list-style-type: none">• Mic: File recorded using the mic capsule• Tr1, Tr2: Files recorded using tracks 1 and 2• TrLR: File that is a stereo mix of all tracks



NOTE

- If a file exceeds 2 GB in size, a new file folder and recording file(s) will be created automatically and recording will continue without pause. New file folders and recording files created this way will be named by adding “_001” to their original file names after the time.
- Depending on the setting, a file that is a stereo mix of all tracks will be created. (→ [Setting whether to record mix files](#))

Checking files

On the [File List Screen](#), files on the microSD card can be checked while playing them.

When the Menu bar is open, the [Playback Screen](#) can be opened for the selected file and that file can also be moved to the trash.

1. On the [Home Screen](#) or [Playback Screen](#), use the  (selection) dial to select  (FILE LIST) and press the  (ENTER) button.



This opens the [File List Screen](#), which lists the files on the microSD card.



2. Use the  (selection) dial to select a file and press the  (ENTER) button.

A menu bar that enables operations on the selected file will appear.



Use the  (selection) dial to select setting items and press the  (ENTER) button to conduct operations. (→ [File List Screen](#))

NOTE

On the [File List Screen](#), all the files in a file folder are treated as one file. For example, if two files named "240101_000000_Tr1.WAV" and "240101_000000_Tr2.WAV" have been created in a file folder, they will be shown as a single file named "240101_000000" on the File List Screen. If this file is selected and deleted, this operation will be applied to all files in the file folder. (→ [H5studio folder and file structure](#))

HINT

Press the  (STOP) button to return to the Home Screen. (→ [Home Screen](#))

Using as an audio interface

Signals input to the H5studio can be sent to a computer, smartphone or tablet, and playback signals from that device can be output from the H5studio.

Moreover, the H5studio can record even when it is being used as an audio interface.

No driver is necessary for use with smartphones, tablets or Mac computers.

A driver is necessary for use with Windows computers.

For Windows

1. Download the H5studio Driver to the computer from zoomcorp.com/help/h5studio.

NOTE

The latest H5studio Driver can be downloaded from the above website.

2. Launch the installer and follow the instructions to install the H5studio Driver.

NOTE

See the Installation Guide included in the driver package for detailed installation procedures.

Connecting to computers, smartphones and tablets

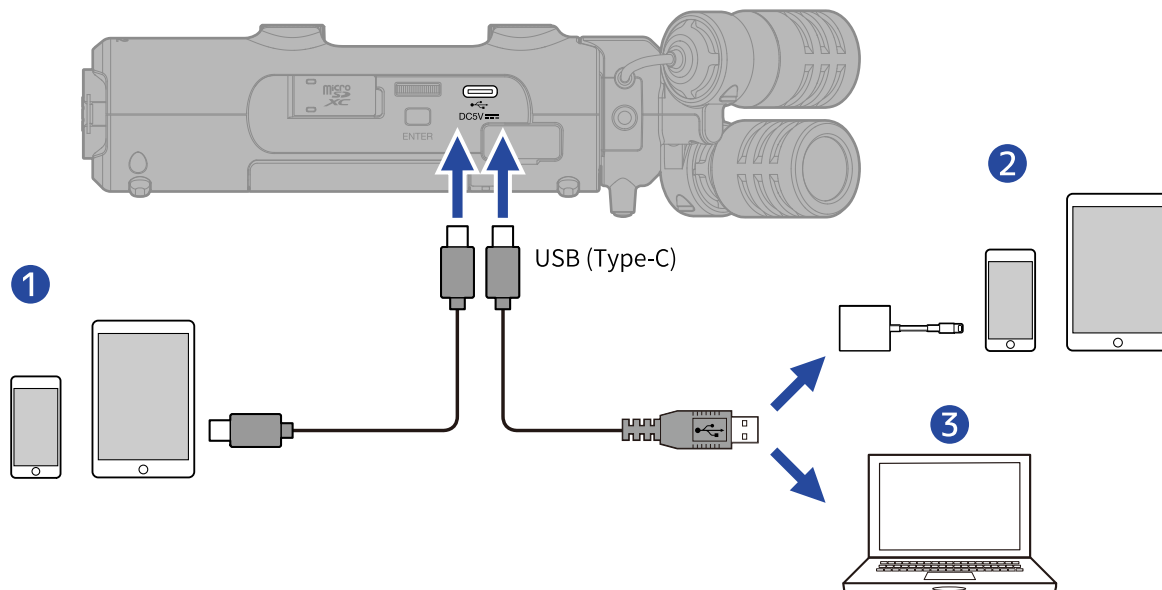

1. Use a USB (Type-C) cable to connect the H5studio with a computer, smartphone or tablet.



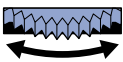

- 1 Smartphone/tablet (USB Type-C)
- 2 iPhone/iPad (Lightning)
- 3 Computer (Windows/Mac)

NOTE



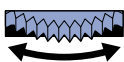

- Use a USB cable that supports data transfer.
- A Lightning to USB 3 Camera Adapter is necessary to connect to an iPhone/iPad with a Lightning connector.
- Connection is not possible using a Type-C to Lightning cable.

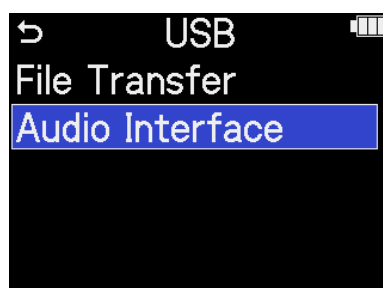
2. On the Home Screen, use the  (selection) dial to select  (USB) and press the  (ENTER) button.
The USB screen will open.

3. Use the  (selection) dial to select "Audio Interface" and press the  (ENTER) button to confirm.





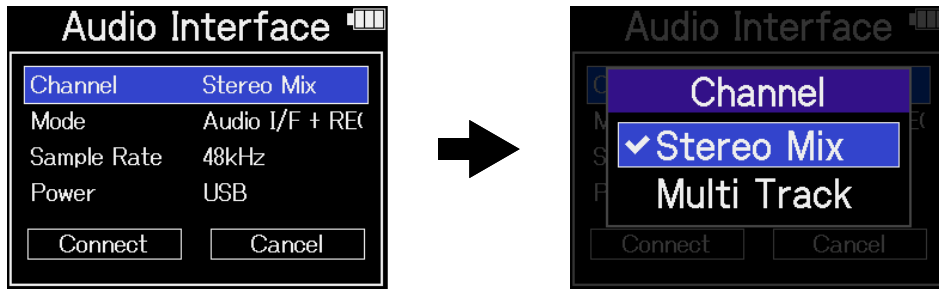

4. Set the channels to output to the computer, smartphone or tablet.

Use the  (selection) dial to select "Channel" and press the  (ENTER) button. Then, use the  (selection) dial to select the channels and press the  (ENTER) button.



Setting value	Explanation
Stereo mix	This will make a stereo mix of all inputs with the balance of levels adjusted by the  (GAIN) knobs and output two channels to the computer, smartphone or tablet. (→ Adjusting the overall level balance)
Multi Track	This will output each input separately as 4 channels to the computer, smartphone or tablet.

5. Set whether to record simultaneously with the H5studio.

Use the  (selection) dial to select "Mode" and press the  (ENTER) button. Then, use the  (selection) dial to select the mode and press the  (ENTER) button.

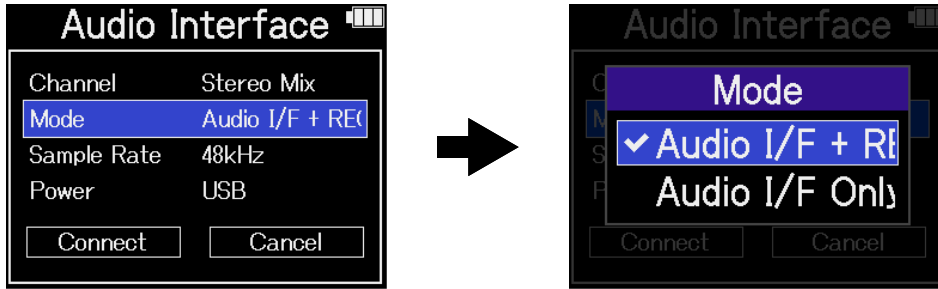

Setting value	Explanation
Audio I/F + REC	The H5studio can record and play back even when it is being used as an audio interface. For details about this function, see "Recording on the H5studio while using it as an audio interface" .
Audio I/F Only	The H5studio will not record or play back when it is being used as an audio interface.





NOTE

When "Audio I/F Only" is selected, the sample rate, which can be set from the computer, smartphone or tablet, has 44.1 kHz, 48 kHz and 96 kHz options.

HINT

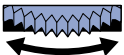

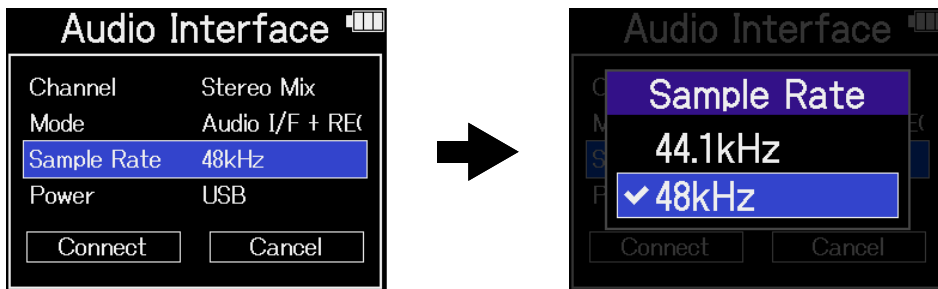

Using "Audio I/F + REC" mode, the H5studio sample rate setting cannot be changed from the computer, smartphone or tablet. To set the sample rate from a computer, smartphone or tablet, use "Audio I/F Only" mode.

6. Select the Sample Rate (when the Mode is "Audio I/F + REC").

Use the  (selection) dial to select "Sample Rate" and press the  (ENTER) button. Then, use the  (selection) dial to select the sample rate and press the  (ENTER) button.

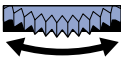

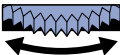
7. Select the power supply.

Use the  (selection) dial to select "Power" and press the  (ENTER) button. Then, use the  (selection) dial to select the power supply and press the  (ENTER) button.

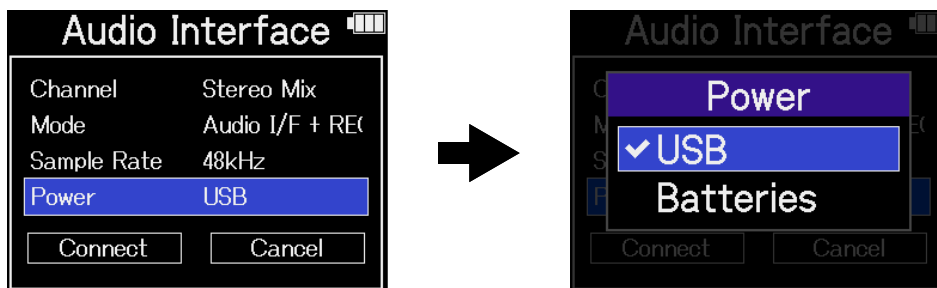

Setting value	Explanation
USB	Power will be supplied using USB bus power.
Batteries	The batteries in the unit will be used.

NOTE

- When "USB" is selected, power is supplied through the USB cable from the computer. Depending on the USB bus power supply capacity of the computer, operation using bus power might not be possible. If this is the case, select "Batteries" and operate using batteries when connected.
- When "Batteries" is selected, power will not be supplied from the other device. Instead, the H5studio will operate using the batteries in it.

8. Use the (selection) dial to select "Connect" and press the (ENTER) button to confirm. This connects with the computer, smartphone or tablet.



9. Launch an application on the computer, smartphone or tablet, and select "H5studio" as the "Audio" or "Input/Output" device.

NOTE

- If "H5studio" cannot be selected for the "Sound" setting on a computer, it can still be used as a 32-bit float audio interface by selecting "H5studio" as the "Audio" or "Input/Output" device in an application that supports 32-bit float format.
- See the operation manuals of applications for information about their operation.

Making input settings and monitoring adjustments

When using the H5studio as an audio interface, input settings and monitoring adjustments can be made in the same way as when using it as a recorder.

See the references below and make input settings and monitoring adjustments.



Reference	Explanation
Enabling tracks for recording	Select MIC (mic capsule) and/or INPUT 1 and 2 as the inputs.
Converting mic capsule input to mono	Mic capsule input can be mixed to a single channel and handled as mono audio.
Using plug-in power	Turn on the plugin power setting when a mic that is compatible with plug-in power is connected to the MIC/LINE IN jack.
Setting the input level (mic/line)	The input level can be set according to the devices connected to the H5studio INPUT 1 and 2.
Setting phantom power	INPUT 1 and 2 support phantom power and can provide +48 V. Turn on phantom power when condenser mics that require it are connected. This can be turned on/off separately for each input.
Reducing noise (Low Cut)	Low frequencies can be cut to reduce the sound of wind and vocal pop noises, for example. This can be set separately for each input.
Setting the Advanced Limiter	This limiter can be turned on/off on each track.
Enabling stereo linking	Using stereo-linking, input signals can also be handled as stereo audio. When the stereo setting is used, INPUT 1 will become the left channel and INPUT 2 will become the right channel. When the mid-side stereo setting is used, INPUT 1 will become the mid signal and INPUT 2 will become the side signal. Mid captures sound front and center while Side captures sound left and right. The stereo width can be changed by adjusting the Side level.
Linking gain knobs	The gain controls can be set to be linked for the L and R channels of the mic capsule as well as for INPUT 1 and INPUT 2.
Adjusting input gain	Use the  (GAIN) knobs for each track to adjust their input gains.
Monitoring input sounds	Use headphones, for example, to monitor input sounds and adjust levels.

Reference	Explanation
Adjusting the overall level balance	The  GAIN knobs can be used to adjust the monitoring mix of the input sounds. Moreover, the volumes of the input sounds and their stereo mix signal can be checked with the level meters.

Making output settings



Adjusting the USB output level

The level output by USB to the computer, smartphone or tablet can be adjusted.

1. On the [Home Screen](#) when in audio interface mode, use the  (selection) dial to select  (Output) and press the  (ENTER) button. This opens the Output Settings Screen.

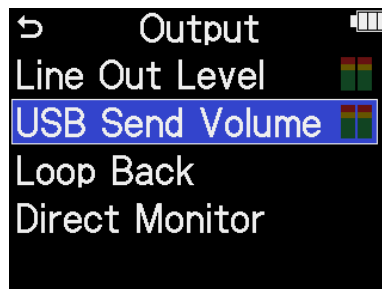
2. Use the  (selection) dial to select “USB Send Volume” and press the  (ENTER) button.

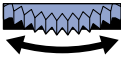

3. Use the  (selection) dial to adjust the USB output level and press the  (ENTER) button. The output level meters can be checked while adjusting.

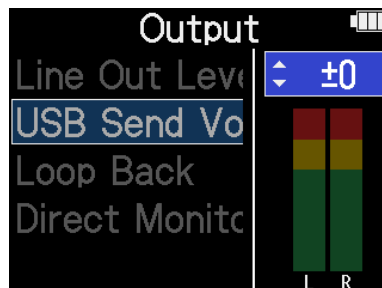

NOTE



This setting does not affect the recorded audio or the audio levels output from the headphone jack or the LINE OUT jack.



HINT

- This can be set to “Mute” or from -40 to +40.
- Selecting “Mute” silences the output from the USB port.

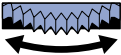

Enabling the loopback function

This function allows playback sound from a computer, smartphone or tablet and sounds input to the H5studio to be mixed and sent again (looped back) to the computer, smartphone or tablet. This function can be used to add narration to music played back from a computer and to record the mix or stream it on that computer, for example.

1. On the [Home Screen](#) when in audio interface mode, use the  (selection) dial to select  (Output) and press the  (ENTER) button. This opens the Output Settings Screen.

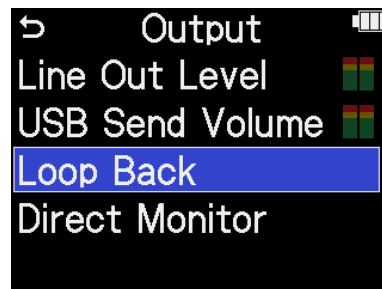
2. Use the  (selection) dial to select "Loop Back" and press the  (ENTER) button.

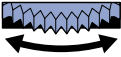

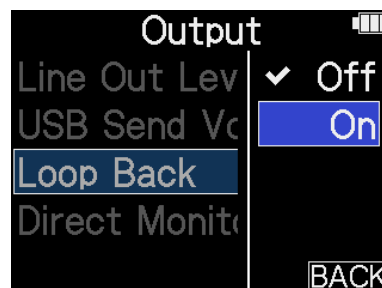

3. Use the  (selection) dial to select "On" or "Off" and press the  (ENTER) button. Selecting "On" turns on the loopback function.



Enabling direct monitoring



The sound being input to the H5studio can be directly output from it before sending the sound to the computer, smartphone or tablet.

This enables monitoring without latency (direct monitoring function).

1. On the [Home Screen](#) when in audio interface mode, use the  (selection) dial to select  (Output) and press the  (ENTER) button. This opens the Output Settings Screen.

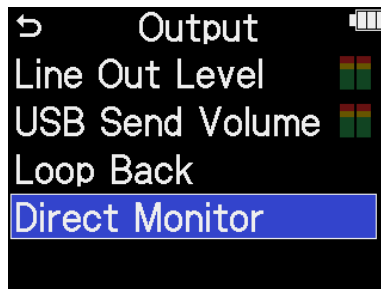
2. Use the  (selection) dial to select "Direct Monitor" and press the  (ENTER) button.

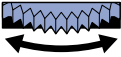

3. Use the  (selection) dial to select "On" or "Off" and press the  (ENTER) button. Selecting "On" turns on the direct monitoring function.

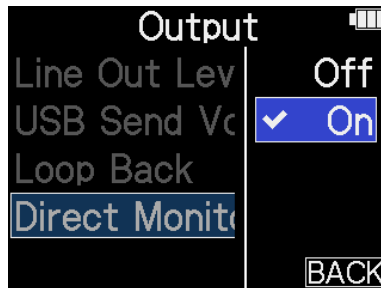

Recording on the H5studio while using it as an audio interface

As explained in "[Connecting to computers, smartphones and tablets](#)", the H5studio can record while it is being used as an audio interface if the Mode is set to "Audio I/F + REC". In this case, recording settings can be made in the same way as when using it as a recorder.

See the references below and make recording settings.

Reference	Explanation
Setting the recording mode	16/24bit Fixed or 32bit Float can be selected for recording files.
Setting whether to record mix files	The recording of stereo mix files can be disabled to save SD card space.
Setting the Advanced Limiter for mix files	This limiter can be turned on/off for mix files.
Capturing audio before recording starts (pre-recording)	The input signal is always buffered for a set amount of time, so it can be captured (pre-recorded) for up to 6 seconds before the time when the  (REC) button is operated to start recording.
Enabling the recording start tone	Half-second tone signals (recording start tones) can be output from the PHONE/LINE OUT jack when recording is started.
Writing metadata (iXML chunks) to recording files	Various related information (metadata) stored in iXML chunks can be written to recorded files.

NOTE

The following settings cannot be changed when the Mode is set to "Audio I/F + REC" as explained in "[Connecting to computers, smartphones and tablets](#)".

- The sample rate of the H5studio
- The bit depth of the H5studio when the recording mode is "16/24-bit Fixed"



To change the sample rate, disconnect from the computer, smartphone or tablet. Then, follow step 6 of "[Connecting to computers, smartphones and tablets](#)".

To change the bit depth, disconnect from the computer, smartphone or tablet first. (→ [Selecting the bit depth](#))

HINT

Press the  (PLAY/PAUSE button) to open the [Playback Screen](#) where recorded files can be played back. (→ [Playing recordings](#))

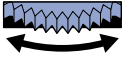
Disconnecting from computers, smartphones and tablets

1. On the Home Screen, use the  (selection) dial to select  (EXIT) and press the  (ENTER) button.

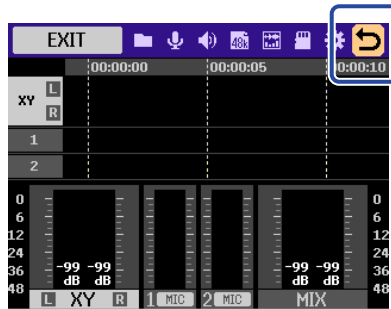

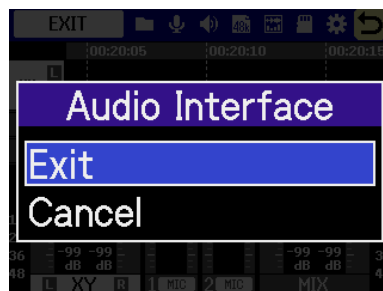

2. Use the  (selection) dial to select "Exit" and press the  (ENTER) button.



Transferring files to computers and other devices

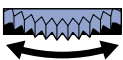

By connecting the H5studio with a computer, smartphone or tablet, files on the microSD card can be checked and moved.

Connecting to computers, smartphones and tablets

1. On the [Home Screen](#), use the  (selection) dial to select  (USB) and press the  (ENTER) button.
The USB screen will open.

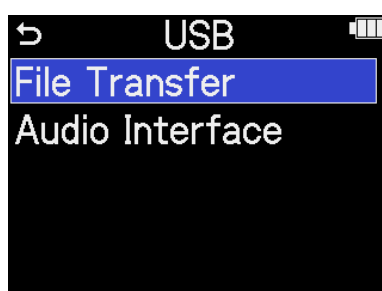
2. Use the  (selection) dial to select "File Transfer" and press the  (ENTER) button to confirm.

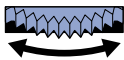

3. Use the  (selection) dial to select the power supply and press the  (ENTER) button to confirm.

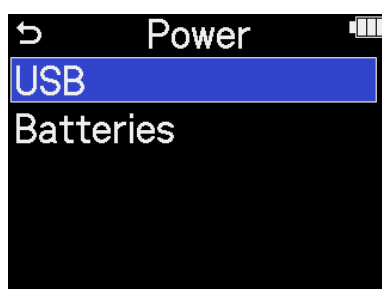

Setting value	Explanation
USB	Power will be supplied using USB bus power.
Batteries	The batteries in the unit will be used.

The File Transfer Screen will open.

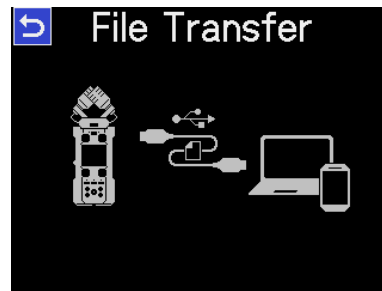

NOTE

- When "USB" is selected, power is supplied through the USB cable from the computer. Depending on the USB bus power supply capacity of the computer, operation using bus power might not be possible. If this is the case, select "Batteries" and operate using batteries when connected.
- When "Batteries" is selected, power will not be supplied from the other device. Instead, the H5studio will operate using the batteries in it.

4. Use a USB (Type-C) cable to connect the H5studio with a computer, smartphone or tablet.

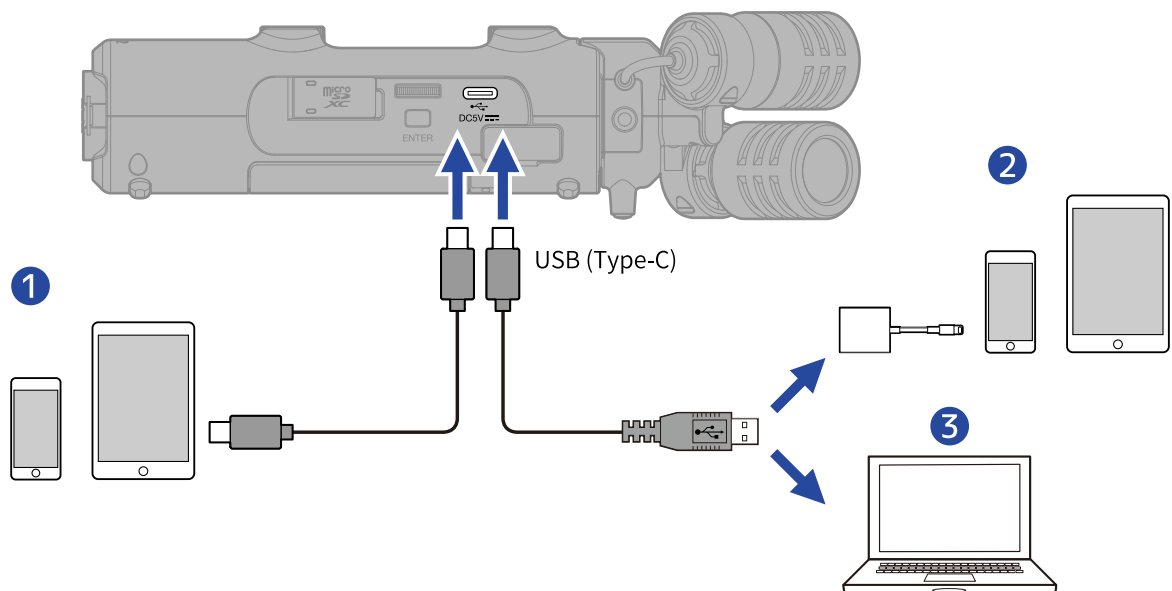

- 1** Smartphone/tablet (USB Type-C)
- 2** iPhone/iPad (Lightning)
- 3** Computer (Windows/Mac)

NOTE

- Use a USB cable that supports data transfer.
- A Lightning to USB 3 Camera Adapter is necessary to connect to an iPhone/iPad with a Lightning connector.

5. Use the computer, smartphone or tablet to work with the files saved on the microSD card.



Disconnecting from computers, smartphones and tablets

1. Conduct disconnection procedures on the computer, smartphone or tablet.

- Windows:
Select the H5studio from "Safely Remove Hardware".
- macOS:
Drag the H5studio icon to the Trash and drop it.
- Smartphone/tablet:
See the operation manual for the device.

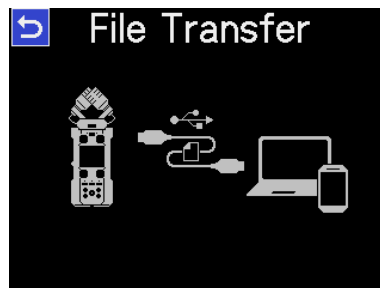
2. Press the  (ENTER) button.

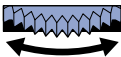

3. Use the  (selection) dial to select "Exit" and press the  (ENTER) button to confirm.

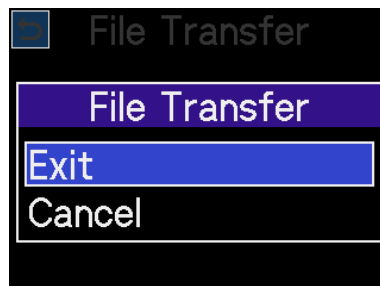



This reopens the [Home Screen](#).

Managing microSD cards

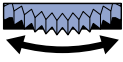

Formatting microSD cards

To maximize the performance of a microSD card, use the H5studio to format it.

1. On the Home Screen, use the  (selection) dial to select  (SD CARD) and press the  (ENTER) button.
The SD Card screen will open.

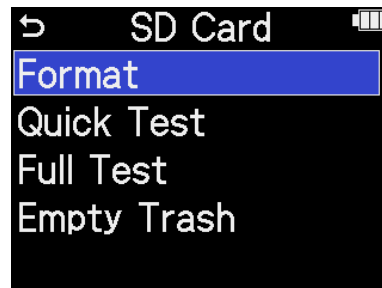
2. Use the  (selection) dial to select "Format" and press the  (ENTER) button.

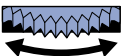

3. Use the  (selection) dial to select "Execute" and press the  (ENTER) button.

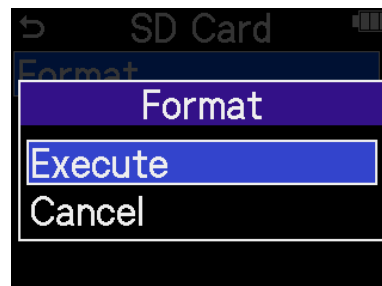

The microSD card will be formatted.

NOTE



- The microSD card formatting screen can also be opened by pressing the  (REC) button while turning the power on.
- Be aware that all data on the microSD card will be deleted when it is formatted.

Testing microSD cards



The writing speed of microSD cards can be tested to check if performance is good enough to save data recorded by the H5studio.

A Quick Test can be done in a short amount of time, while a Full Test examines the entire microSD card.



Conducting a quick test

1. On the Home Screen, use the  (selection) dial to select  (SD CARD) and press the  (ENTER) button.

The SD Card screen will open.

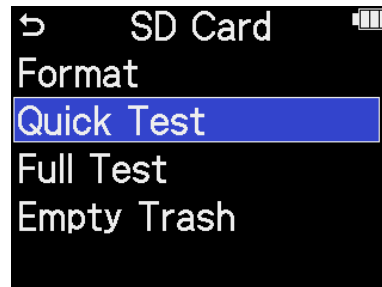
2. Use the  (selection) dial to select "Quick Test" and press the  (ENTER) button.



3. Use the  (selection) dial to select "Execute" and press the  (ENTER) button.

The card performance test will start.

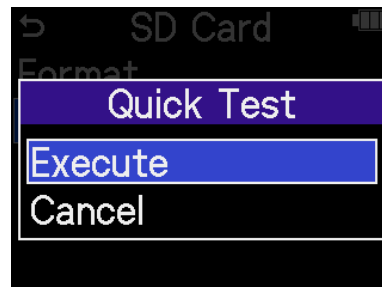

The result of the test will be shown when it completes.

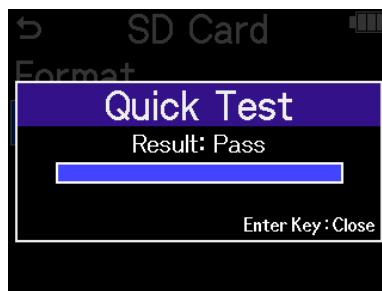



NOTE



Even if a performance test result is "Pass", there is no guarantee that writing errors will not occur. This information is just to provide guidance.

HINT

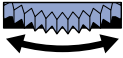
During a test, the  (ENTER) button can be pressed to stop it.



Conducting a full test

1. On the Home Screen, use the  (selection) dial to select  (SD CARD) and press the  (ENTER) button.
The SD Card screen will open.

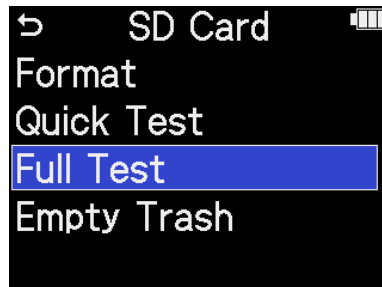
2. Use the  (selection) dial to select "Full Test" and press the  (ENTER) button.

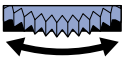

The amount of time required for the full test will be shown.

3. Use the  (selection) dial to select "Execute" and press the  (ENTER) button.
The card performance test will start.

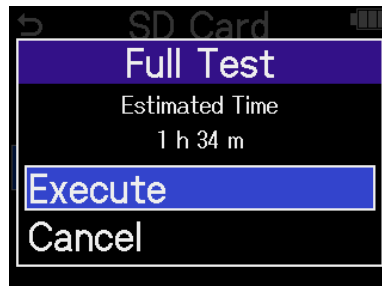

The result of the test will be shown when it completes.
If Access Rate Max. reaches 100%, the card will fail (NG).

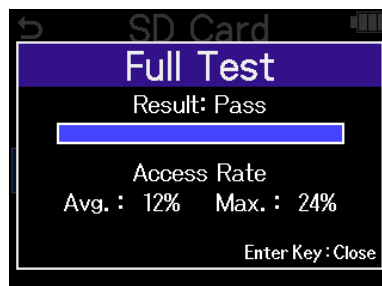

NOTE



Even if a performance test result is "Pass", there is no guarantee that writing errors will not occur. This information is just to provide guidance.



HINT

During a test, the  (ENTER) button can be pressed to stop it.

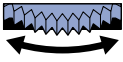

Deleting files in the TRASH folder

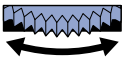
Files moved to the trash can be deleted to empty the trash and increase open space on the SD card.

1. On the Home Screen, use the  (selection) dial to select  (SD CARD) and press the  (ENTER) button.
The SD Card screen will open.

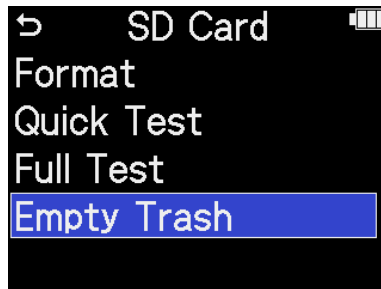
2. Use the  (selection) dial to select "Empty Trash" and press the  (ENTER) button.

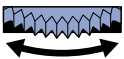

3. Use the  (selection) dial to select "Execute" and press the  (ENTER) button.

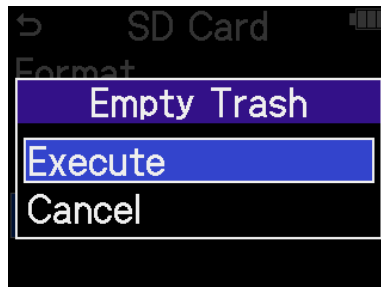

This deletes all files in the trash.

NOTE

This operation cannot be undone. Be certain beforehand.

Using timecode

Timecode overview

SMPTe timecode can be input to the H5studio by using an UltraSync BLUE made by ATOMOS/Timecode Systems.

Timecode is time information written to data when recording video and audio. It is used for video editing, control of other devices, and synchronization of audio and video, for example.

NOTE

- An ATOMOS/Timecode Systems UltraSync BLUE cannot be used during audio interface operation (→ [Using as an audio interface](#)).
- An H5studio cannot have both ZOOM Handy Control & Sync and an UltraSync BLUE connected at the same time.

Using timecode for editing

If video and audio data both have recorded timecode, aligning them to a timeline and synchronizing them together is easy when using nonlinear editing software for editing.

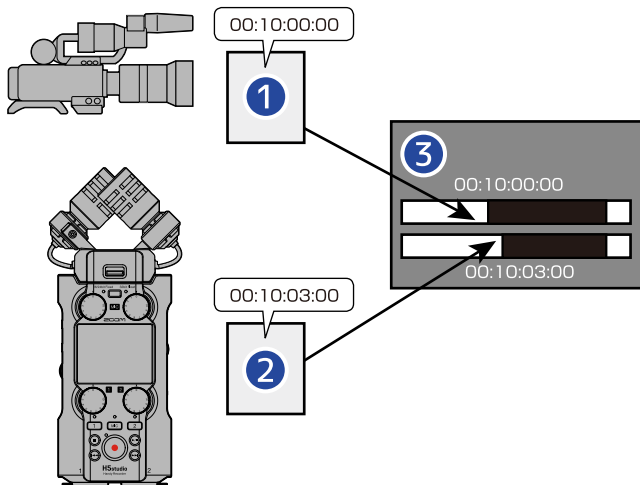

- 1 Video file with timecode recorded
- 2 Audio file with timecode recorded
- 3 Nonlinear editing software

Inputting timecode

The UltraSync BLUE made by ATOMOS/Timecode Systems transmits timecode, which is received by both the H5studio and the video camera, resulting in timecode being recorded in the data for both the audio and the video.

The timecode is transmitted and received by Bluetooth.

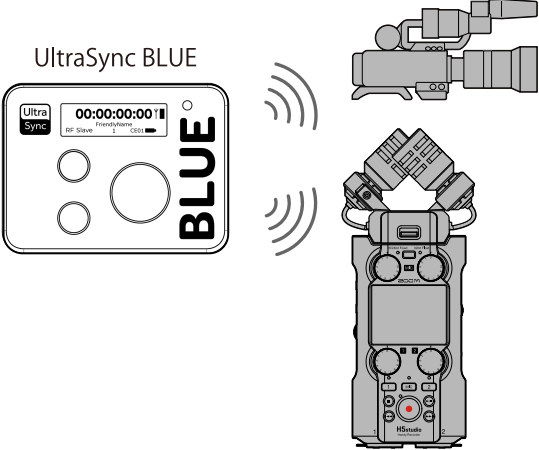



Connecting with an UltraSync BLUE

If the H5studio is connected to an UltraSync BLUE, it can receive timecode from the UltraSync BLUE and add it to recording files.

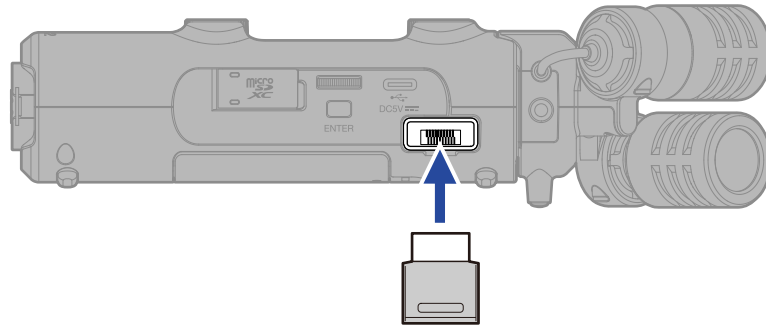

To connect an UltraSync BLUE, a BTA-1 or another dedicated wireless adapter must be connected to the H5studio. Then, the UltraSync BLUE and the H5studio must be paired.

1. With the H5studio power off, remove the REMOTE connector cover on the right side. Then, connect the BTA-1 or another dedicated wireless adapter.



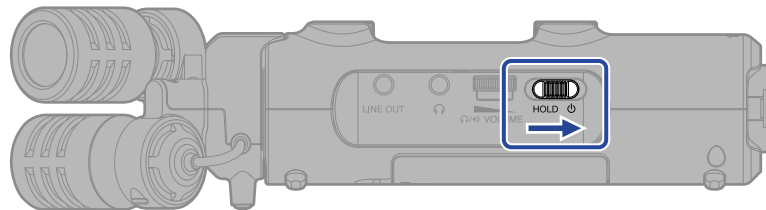

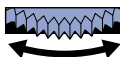
2. Slide the  (POWER/HOLD) switch toward  (in the direction of the INPUT 1 and 2 jacks) to turn on the power.

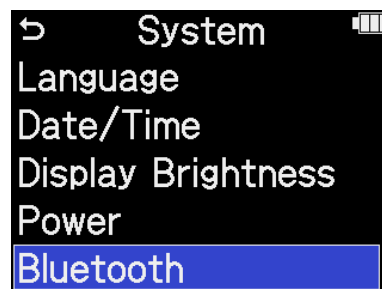

3. On the [Home Screen](#), use the  (selection) dial to select  (SYSTEM) and press the  (ENTER) button. This opens the System Settings Screen.

4. Use the  (selection) dial to select "Bluetooth" and press the  (ENTER) button.

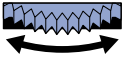

5. Use the  (selection) dial to select “Timecode” and press the  (ENTER) button.

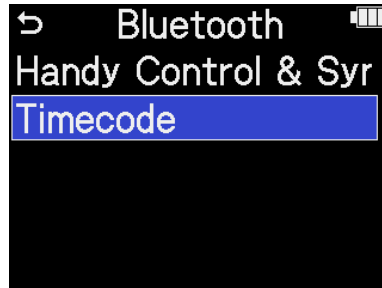

Searching for the device to connect will begin and “Searching...” will appear on the display.

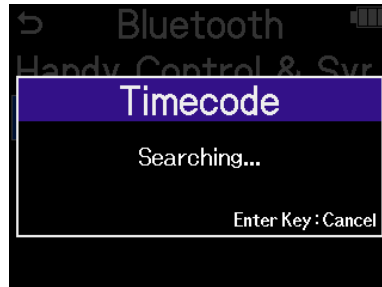

NOTE

If the H5studio and an UltraSync BLUE have been connected before, make a selection when the following screen appears.

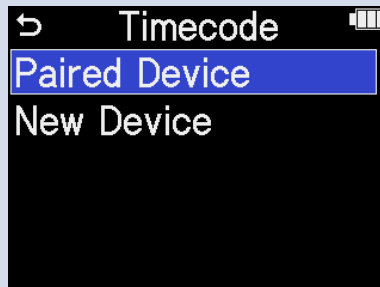

Setting value	Explanation
Paired Device	Select this to connect to the UltraSync BLUE that was connected the previous time. In this case, connection will be made with the UltraSync BLUE and its operation described in step 6 becomes unnecessary.
New Device	Select this to connect to a different UltraSync BLUE than the one that was connected the previous time. Selecting “New Device” will erase information about the previously paired device. Proceed to step 6.

HINT

Searching can be canceled by pressing the  (ENTER) button.

6. Operate the UltraSync BLUE and select the H5studio as a connected device.

This starts pairing.

When pairing completes, "Timecode device connected" will appear on the H5studio display.

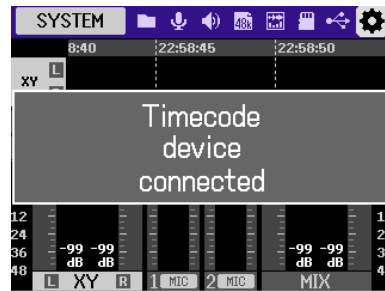

HINT

- See the UltraSync BLUE manual for the procedures to select connected devices.
- Use the H5studio and the UltraSync BLUE as close together as possible to make communication more reliable.
- If communication with the UltraSync BLUE is interrupted while recording, timecode data will not be added to the remainder of the recording.
- If communication occurred previously with an UltraSync BLUE, reconnection will occur automatically with that UltraSync BLUE after step 2.

Checking timecode data

While timecode is being received from an UltraSync BLUE, timecode data can be checked on the [Home Screen](#).

The timecode appears above the recordable time on the [Home Screen](#) as the hour, minute, second and frame.

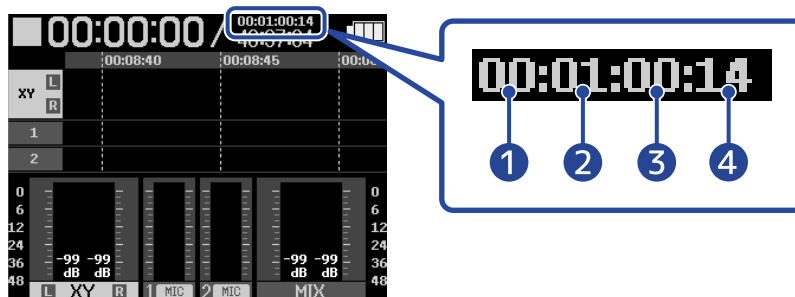

- 1 Hour
- 2 Minute
- 3 Second
- 4 Frame



Disconnecting from an UltraSync BLUE

Removing the BTA-1 from the H5studio will disconnect the H5studio from the UltraSync BLUE and stop timecode recording. Pairing information will be retained even when disconnected.

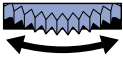

Making various settings

Setting the language shown

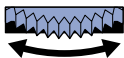

The language shown on H5studio screens can be changed.

1. On the [Home Screen](#), use the  (selection) dial to select  (SYSTEM) and press the  (ENTER) button.

This opens the System Settings Screen.

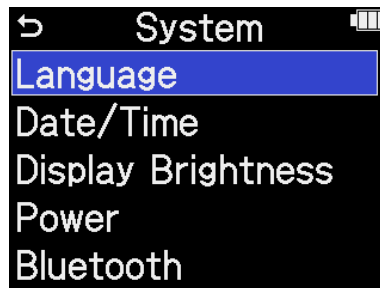
2. Use the  (selection) dial to select "Language" and press the  (ENTER) button.

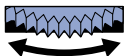

3. Use the  (selection) dial to select the language to use and press the  (ENTER) button.

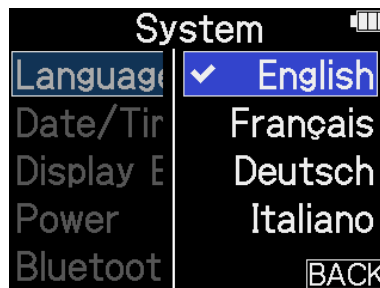



HINT

The first time you turn the power on after purchase or restoring default settings, this screen opens automatically after setting the guide sound.

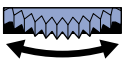

Setting the date and time

Use this to set the date and time added to recording files.

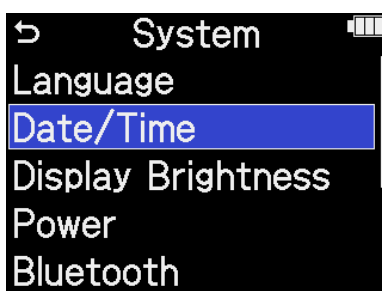

1. On the [Home Screen](#), use the  (selection) dial to select  (SYSTEM) and press the  (ENTER) button.
This opens the System Settings Screen.

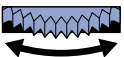
2. Use the  (selection) dial to select "Date/Time" and press the  (ENTER) button.



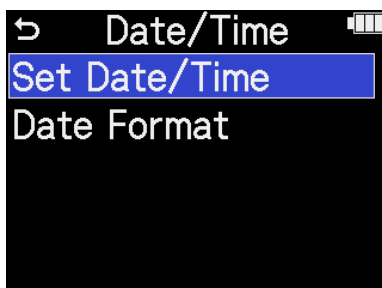

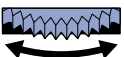
3. Use the  (selection) dial to select "Set Date/Time" and press the  (ENTER) button.



4. Use the  (selection) dial to select the desired item to set and press the  (ENTER) button.

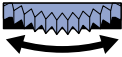

5. Use the  (selection) dial to change the value and press the  (ENTER) button.



6. Repeat steps 4-5 to set the date and time.

7. After setting all the items, use the  (selection) dial to select  and press the  (ENTER) button.







HINT

The first time you turn the power on after purchase or restoring default settings, this screen opens automatically after setting the date format.

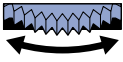
Setting the date format

Use this to change the date format used when recording files.

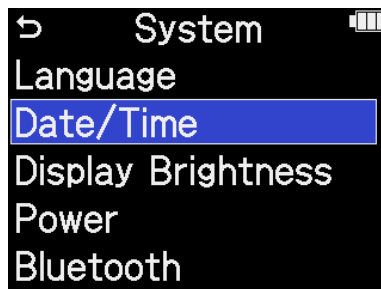

1. On the [Home Screen](#), use the  (selection) dial to select  (SYSTEM) and press the  (ENTER) button.
This opens the System Settings Screen.

2. Use the  (selection) dial to select "Date/Time" and press the  (ENTER) button.

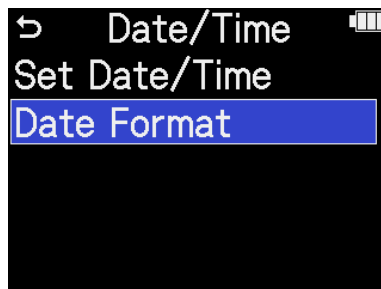

3. Use the  (selection) dial to select "Date Format" and press the  (ENTER) button.

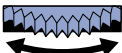

4. Use the  (selection) dial to select the date format and press the  (ENTER) button.

A specific example of the set date format will be shown at the bottom right of the screen using the current date setting.





Setting value	Explanation
YYMMDD	The date is shown in year, month, day order.
MMDDYY	The date is shown in month, day, year order.
DDMMYY	The date is shown in day, month, year order.



HINT

The first time you turn the power on after purchase or restoring default settings, this screen opens automatically after setting the language shown.

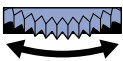

Setting the display brightness

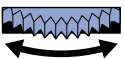
The brightness of the display can be adjusted if it is difficult to see because it is too dim or too bright.

1. On the [Home Screen](#), use the  (selection) dial to select  (SYSTEM) and press the  (ENTER) button.
This opens the System Settings Screen.

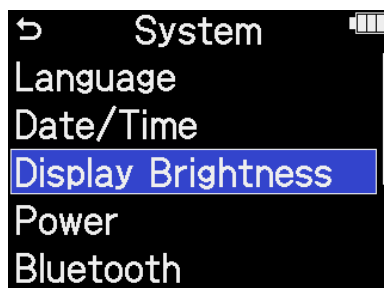
2. Use the  (selection) dial to select "Display Brightness" and press the  (ENTER) button.

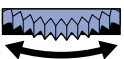

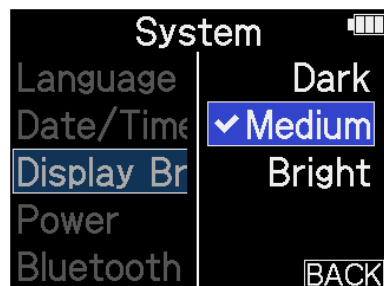

3. Use the  (selection) dial to set the display brightness and press the  (ENTER) button.



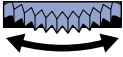

Setting value	Explanation
Dark	The display will be dimmer.
Medium	The display brightness will be normal.
Bright	The display will be brighter.

Setting the type of batteries used

Set the type of batteries used by the H5studio so that the amount of remaining battery charge can be shown accurately.

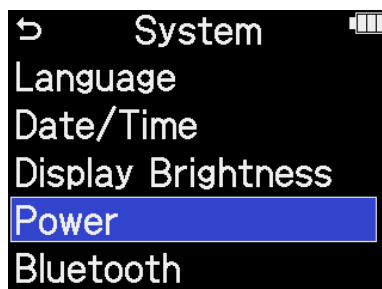

1. On the [Home Screen](#), use the  (selection) dial to select  (SYSTEM) and press the  (ENTER) button.
This opens the System Settings Screen.

2. Use the  (selection) dial to select "Power" and press the  (ENTER) button.

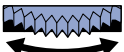

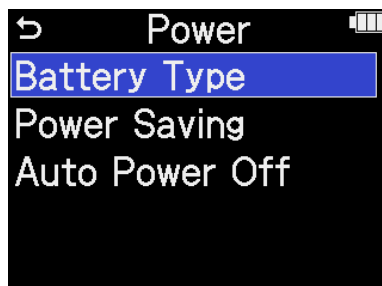
3. Use the  (selection) dial to select "Battery Type" and press the  (ENTER) button.

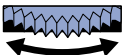

4. Use the  (selection) dial to select the battery type and press the  (ENTER) button.





Setting value	Explanation
Alkaline	Alkaline batteries
Ni-MH	Nickel-metal hydride batteries
Lithium	Lithium batteries



HINT

The first time you turn the power on after purchase or restoring default settings, the battery type setting appears automatically after setting the date and time.

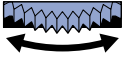

Setting display power saving

In order to conserve energy, the display backlight can be set to dim if no operation is conducted for a specific amount of time.

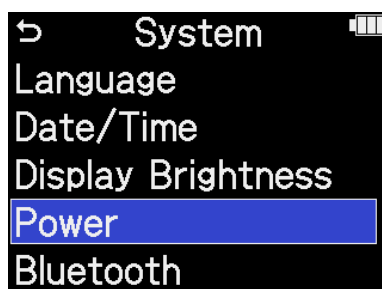

1. On the [Home Screen](#), use the  (selection) dial to select  (SYSTEM) and press the  (ENTER) button.
This opens the System Settings Screen.

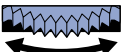
2. Use the  (selection) dial to select "Power" and press the  (ENTER) button.

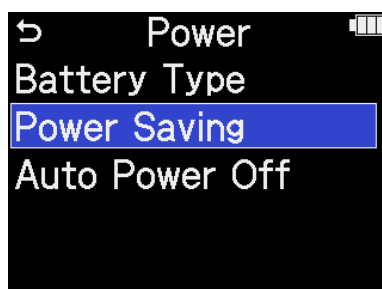

3. Use the  (selection) dial to select "Power Saving" and press the  (ENTER) button.



4. Use the  (selection) dial to select an item and press the  (ENTER) button.

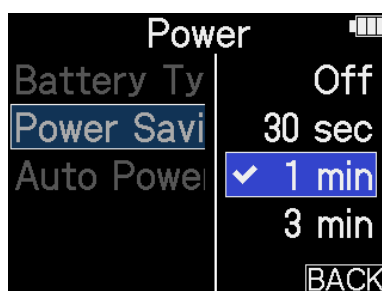



Setting value	Explanation
Off	The display backlight always stays bright.
30 sec, 1 min, 3 min, 5 min	The display backlight will become dark after the set time has elapsed without any operation.



Setting the time until the power turns off automatically

The H5studio can be set so that its power will automatically turn off if it is not used for a set amount of time.

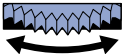

To keep the power on at all times, set Auto Power Off to Off.

1. On the [Home Screen](#), use the  (selection) dial to select  (SYSTEM) and press the  (ENTER) button.

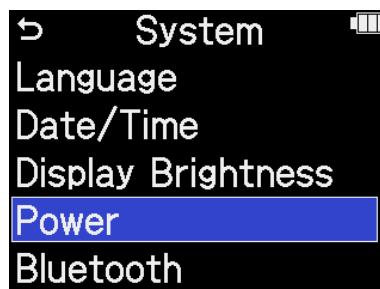

This opens the System Settings Screen.

2. Use the  (selection) dial to select "Power" and press the  (ENTER) button.

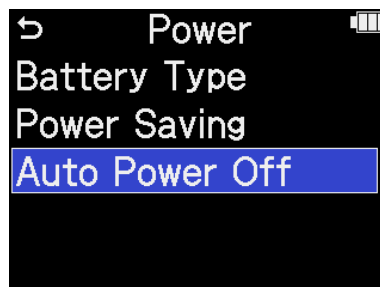

3. Use the  (selection) dial to select "Auto Power Off" and press the  (ENTER) button.



4. Use the  (selection) dial to select the time until the power turns off and press the  (ENTER) button.

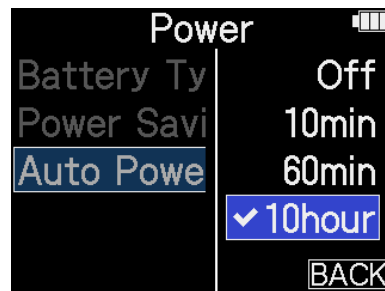

Setting value	Explanation
Off	The power will not turn off automatically.
10 min, 60 min, 10 hour	The power will automatically turn off if no operation occurs for the set time.

NOTE



The power will not turn off automatically under the following conditions regardless of the Auto Power Off setting.



- During recording or playback
- When the H5studio is in use as an audio interface
- When the H5studio file transfer function is in use
- During card tests
- During execution of firmware updates

Using the guide sound accessibility feature

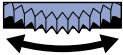

Setting the guide sound (Accessibility)

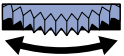
With this function, the names of selected setting items can be read aloud and a beeping sound can be used to notify the occurrence of error messages, recording starting/stopping and volume adjustment, for example.

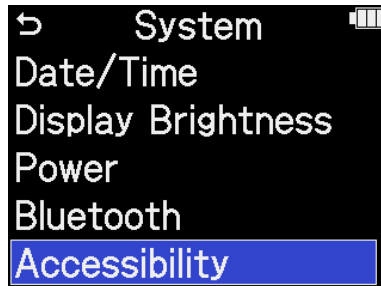

1. On the [Home Screen](#), use the  (selection) dial to select  (SYSTEM) and press the  (ENTER) button.
This opens the System Settings Screen.

2. Use the  (selection) dial to select "Accessibility" and press the  (ENTER) button.

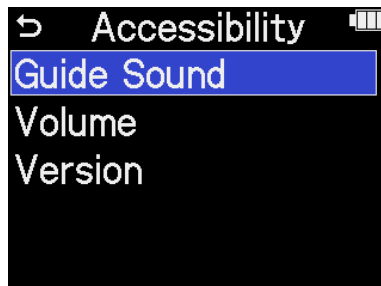

3. Use the  (selection) dial to select "Guide Sound" and press the  (ENTER) button.

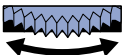

4. Use the  (selection) dial to select the setting item and press the  (ENTER) button.

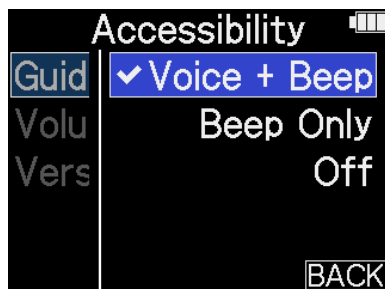

Setting value	Explanation
Voice + Beep	Setting items will be read aloud in the installed language. A beeping sound will be used to notify the occurrence of error messages, recording starting/stopping and volume adjustment, for example. English is installed at the time of purchase, but other languages can be installed and used for reading as desired. (→ Installing guide sounds)
Beep Only	A beeping sound will be used to notify when error messages occur, recording starts/stops and the volume changes, for example. Nothing will be read aloud.
Off	This turns off the guide sound.

NOTE



- The volume of the reading voice and beep sounds can also be adjusted. (→ [Setting the guide sound volume](#))
- The language and version used for the guide sound can be checked on the Version Screen. (→ [Checking guide sound information](#))



HINT

- The first time you turn the power on after purchase, this screen opens automatically.
- The guide sound can be turned on/off immediately by pressing and holding the  (ENTER) button when the Home Screen is open. (→ [Turning the guide sound on/off with a shortcut](#))

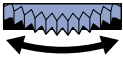

Setting the guide sound volume

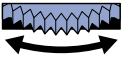
The volume of the reading voice and beep sounds can be adjusted.

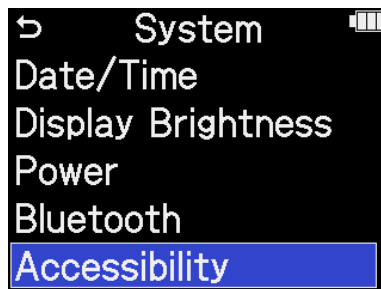

1. On the [Home Screen](#), use the  (selection) dial to select  (SYSTEM) and press the  (ENTER) button.
This opens the System Settings Screen.

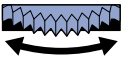
2. Use the  (selection) dial to select "Accessibility" and press the  (ENTER) button.

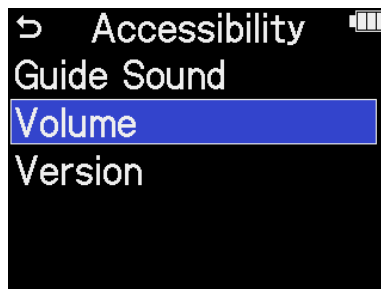

3. Use the  (selection) dial to select "Volume" and press the  (ENTER) button.

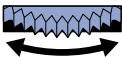

4. Use the  (selection) dial to select the volume and press the  (ENTER) button.

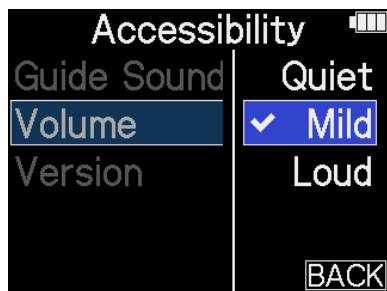

The volume can be set to Quiet, Mild or Loud.

NOTE

The volume determined here is also affected before output by adjustments made using the



(VOLUME) dial. Consider volume adjustments using the

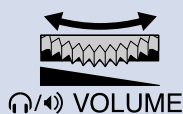





(VOLUME) dial when making this

setting.

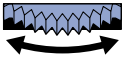

Checking guide sound information

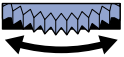
The language and version used for the accessibility guide sounds can be checked.

1. On the [Home Screen](#), use the  (selection) dial to select  (SYSTEM) and press the  (ENTER) button.
This opens the System Settings Screen.

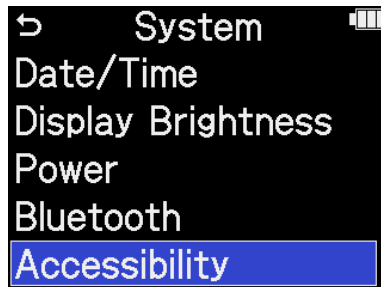
2. Use the  (selection) dial to select "Accessibility" and press the  (ENTER) button.

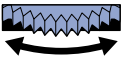

3. Use the  (selection) dial to select "Version" and press the  (ENTER) button.

This opens the Version Screen where the language and version used for the accessibility guide sounds can be checked.

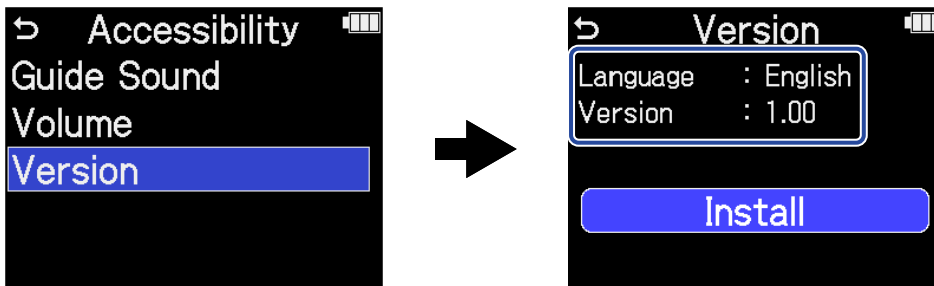

Turning the guide sound on/off with a shortcut

This function allows the guide sound to be turned on/off anytime to suit the use situation.

1. When the [Home Screen](#) is open, press and hold the  (ENTER) button.

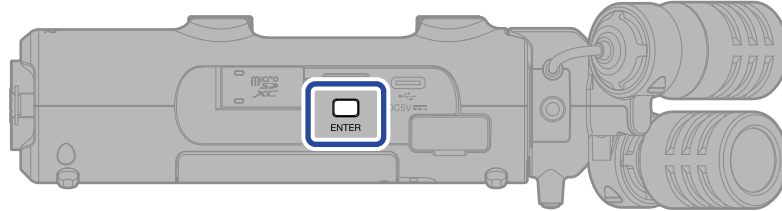

This turns on/off the guide sound.

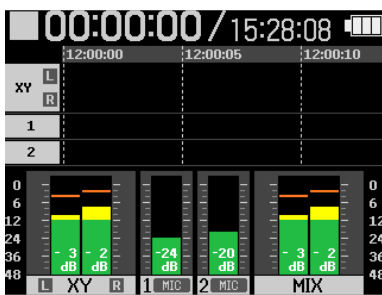

Home Screen

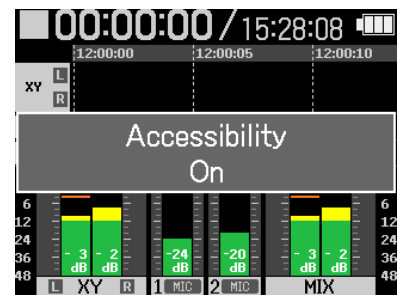

A notification about the switch will be shown (and announced with the guide sound).

Installing guide sounds

The guide sound language is English at the time of purchase.



Guide sound installation can be used to change the language and update the feature.

Download the most recent accessibility installation file necessary to install the guide sound from the ZOOM website (zoomcorp.com/help/h5studio).

Follow the instructions in the "H5studio Accessibility Installation Guide" on the H5studio download page.

Restoring the factory default state

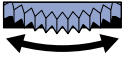
The H5studio can be restored to its factory default state.

1. On the [Home Screen](#), use the  (selection) dial to select  (SYSTEM) and press the  (ENTER) button.
This opens the System Settings Screen.

2. Use the  (selection) dial to select "Reset All Settings" and press the  (ENTER) button.

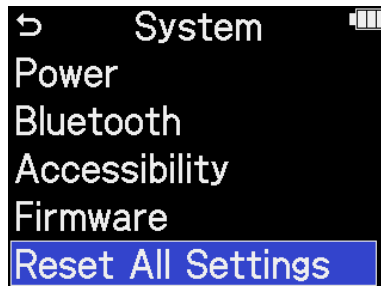

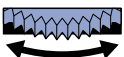
3. Use the  (selection) dial to select "Execute" and press the  (ENTER) button.

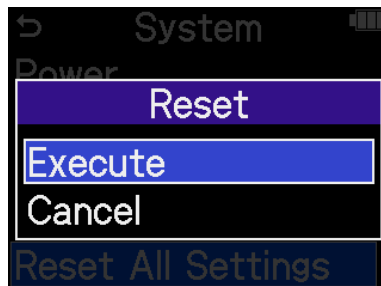

This will restore the H5studio to its factory default state and turn the power off.



NOTE

Initializing settings will overwrite all settings with their factory defaults. Be certain before using this function.

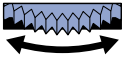

Managing the firmware

Checking firmware versions

The firmware versions used by the H5studio can be checked.

1. On the [Home Screen](#), use the  (selection) dial to select  (SYSTEM) and press the  (ENTER) button.

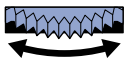
This opens the System Settings Screen.

2. Use the  (selection) dial to select "Firmware" and press the  (ENTER) button.

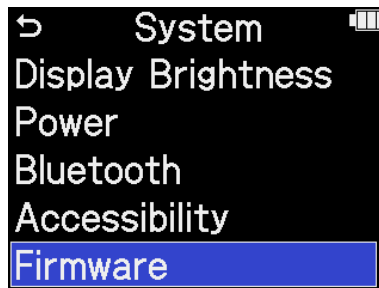

This shows the firmware versions.



Updating the firmware

The H5studio firmware can be updated to the latest versions.

Files for the latest firmware updates can be downloaded from the ZOOM website (zoomcorp.com/help/h5studio).

Follow the instructions in the “H5studio Firmware Update Guide” on the H5studio download page.

Operating the H5studio from a smartphone or tablet

The H5studio can be operated wirelessly from a smartphone or tablet by connecting a BTA-1 or another dedicated wireless adapter and using the ZOOM Handy Control & Sync app designed to control it.

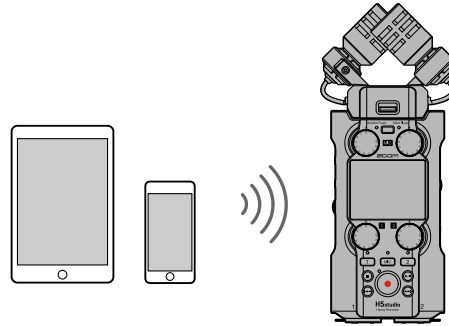



NOTE

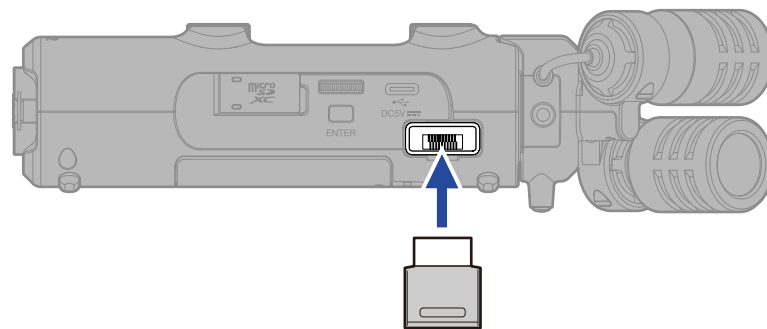

- The ZOOM Handy Control & Sync app must be installed on the smartphone or tablet beforehand. The ZOOM Handy Control & Sync app can be downloaded from the App Store. Refer to the manual for the ZOOM Handy Control & Sync app for details about app settings and operation procedures.
- The H5studio cannot be controlled wirelessly from a smartphone or tablet during audio interface operation (→ [Using as an audio interface](#)).
- An H5studio cannot have both ZOOM Handy Control & Sync and an UltraSync BLUE connected at the same time.

1. With the H5studio power off, remove the REMOTE connector cover on the right side. Then, connect the BTA-1 or another dedicated wireless adapter.

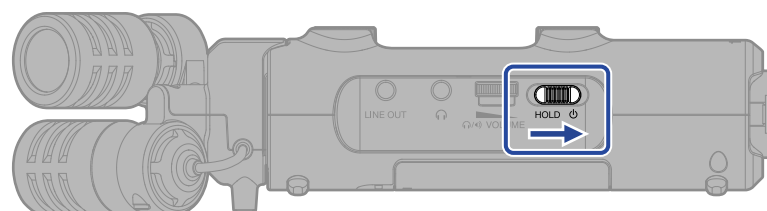

2. Slide the  (POWER/HOLD) switch toward  (in the direction of the INPUT 1 and 2 jacks) to turn on the power.

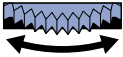

3. On the [Home Screen](#), use the  (selection) dial to select "SYSTEM" and press the  (ENTER) button.

This opens the System Settings Screen.

4. Use the  (selection) dial to select "Bluetooth" and press the  (ENTER) button.

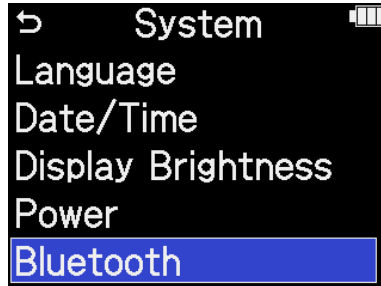

5. Use the  (selection) dial to select "Handy Control & Sync" and press the  (ENTER) button.

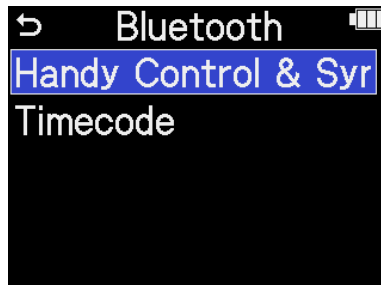

Searching for the device to connect will begin and "Searching" will appear on the display.



HINT

Searching can be canceled by pressing the  (ENTER) button.

6. Launch the ZOOM Handy Control & Sync app on the smartphone or tablet. Then, conduct connection procedures from the app.

When connection completes “Handy Control & Sync Connected” will appear on the display.

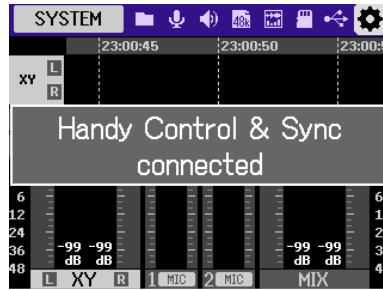

Refer to the manual for the ZOOM Handy Control & Sync app for details about app settings and operation procedures.

HINT

If connection occurred previously with ZOOM Handy Control & Sync, searching for connected devices will begin automatically after step 2.

Checking timecode data

While timecode is being received from a smartphone or tablet, timecode data can be checked on the [Home Screen](#).

The timecode appears above the recordable time on the [Home Screen](#) as the hour, minute, second and frame.

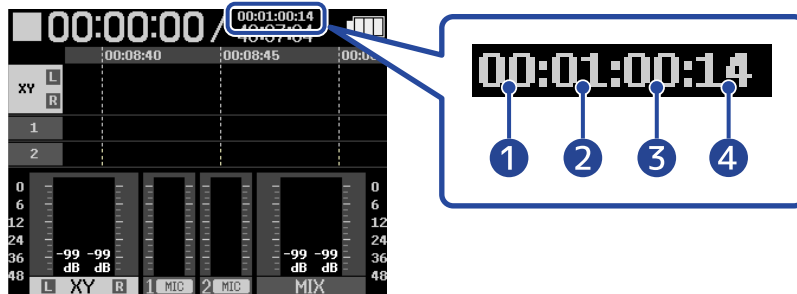

- 1 Hour
- 2 Minute
- 3 Second
- 4 Frame



Disconnecting from smartphones and tablets



Disconnection is possible by quitting the app on the smartphone or tablet.

Removing the BTA-1 from the H5studio will also disconnect it from ZOOM Handy Control & Sync.

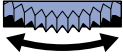
Checking the latest information for the H5studio

A 2D code for help related to the H5studio can be shown on its display.

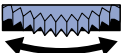
1. On the [Home Screen](#), use the  (selection) dial to select  (SYSTEM) and press the  (ENTER) button.
This opens the System Settings Screen.

2. Use the  (selection) dial to select "Help" and press the  (ENTER) button.

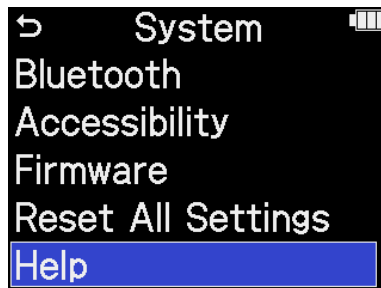

3. Use a smartphone or tablet, for example, to scan the 2D code shown on the Help Screen.



zoomcorp.com/help/h5studio

Using optional mic capsules

The mic capsule included with the H5studio can be swapped with a different mic capsule (sold separately) according to recording needs.

The display and operation when using an optional mic capsule are fundamentally the same as when using the included mic capsule. Settings specific to each mic capsule, however, can be changed.

The following optional mic capsules are compatible with the H5studio.

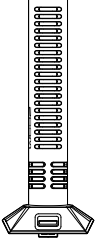
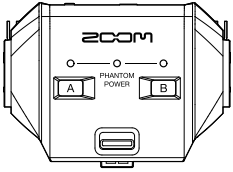
Mic capsule		Explanation
	SSH-6e Shotgun Mic Capsule	Mid-side stereo shotgun mic that supports 32-bit float recording
	EXH-6e External Input	2-channel XLR/TRS input capsule that supports 32-bit float recording

Using an SSH-6e

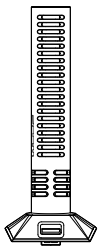

The SSH-6e is a mid-side stereo shotgun mic capsule. Along with a super-directional shotgun mic for capturing sound in the center (mid), it has a bidirectional mic for capturing sound from the left and right (side). The stereo width can be changed freely by adjusting the side level,

NOTE

For details about the SSH-6e, see its manual.



Download the SSH-6e manual from the ZOOM website (zoomcorp.com/help/ssh-6e).

Setting the SSH-6e mode

The operation mode of the SSH-6e.

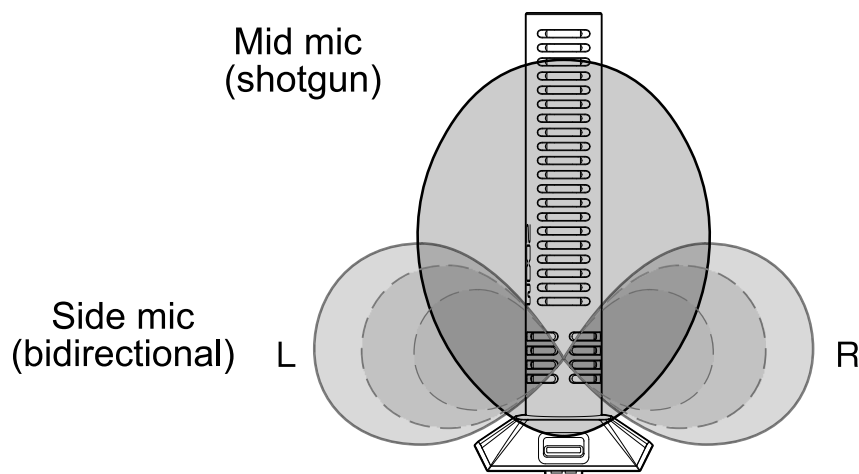

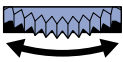
By setting the mode, a wide range of recording styles can be supported, from super-directional mono to stereo, which would normally require using an additional mic.



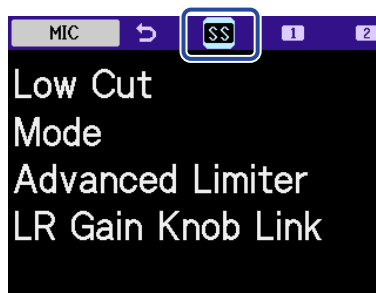

1. On the [Home Screen](#), use the  (selection) dial to select  (INPUT) and press the  (ENTER) button.
This opens the [Input Settings Screen](#).

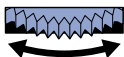
2. Use the  (selection) dial to select  (MIC) and press the  (ENTER) button.

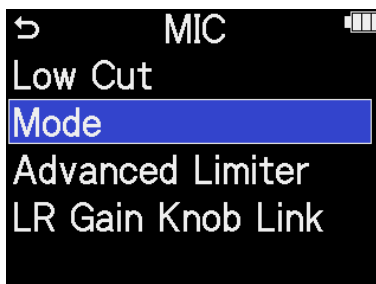

3. Use the  (selection) dial to select "Mode" and press the  (ENTER) button.

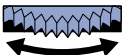

4. Use the  (selection) dial to select the mode to use and press the  (ENTER) button.

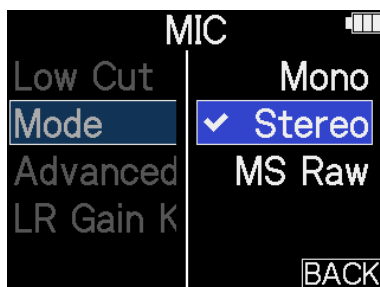

Setting	Explanation
Mono	This turns off the side mic, enabling use as a mono shotgun mic. This is useful for situations when recording only specific sounds is desired.
Stereo	This uses the mid and side mics together as a stereo shotgun mic that keeps stereo width while having directional focus. This is useful for situations when recording sounds from the surrounding environment is also desired.
MS Raw	The mid mic signal will be recorded to the left channel and the side mic signal will be recorded to the right channel of the stereo file. This function is useful for changing the side level during post-production after recording.

HINT



Use the MIC GAIN knobs to adjust the mid-side balance.

Use the left MIC GAIN knob to adjust the mid and the right MIC GAIN knob to adjust the side.

Before doing this, set LR Gain Knob Link to Off. (→ [Linking L and R gain for the SSH-6e](#))

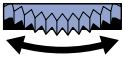

Reducing noise when using an SSH-6e (Low Cut)

Low frequencies can be cut to reduce the sound of wind and vocal pop noises, for example.

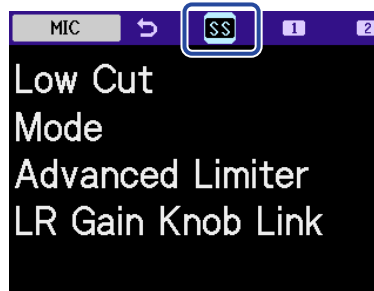

1. On the [Home Screen](#), use the  (selection) dial to select  (INPUT) and press the  (ENTER) button.
This opens the [Input Settings Screen](#).

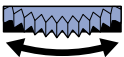
2. Use the  (selection) dial to select  (MIC) and press the  (ENTER) button.

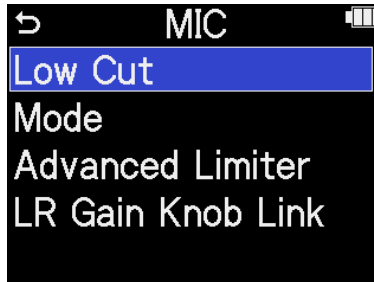

3. Use the  (selection) dial to select "Low Cut" and press the  (ENTER) button.

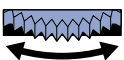

4. Use the  (selection) dial to select the cut frequency and press the  (ENTER) button.

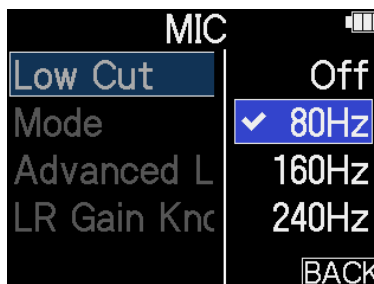



Lo Cut can be set to OFF, 80 Hz, 160 Hz or 240 Hz.

Setting the Advanced Limiter for the SSH-6e

The limiter can be turned on/off for the MIC track.



The H5studio limiter can be set to detect the maximum level in advance and is optimized to prevent distortion.

1. On the [Home Screen](#), use the  (selection) dial to select  (INPUT) and press the  (ENTER) button.

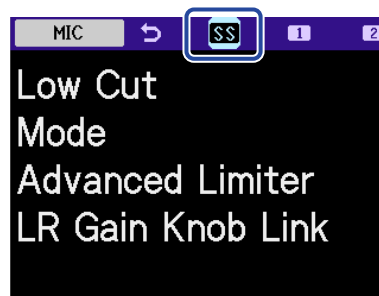

This opens the [Input Settings Screen](#).

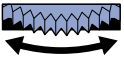
2. Use the  (selection) dial to select  (MIC) and press the  (ENTER) button.

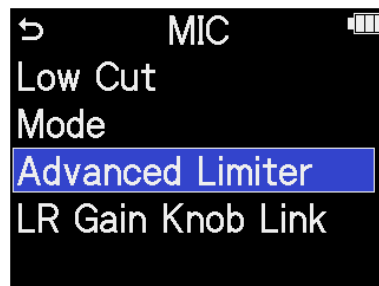

3. Use the  (selection) dial to select "Advanced Limiter" and press the  (ENTER) button.

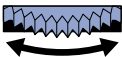

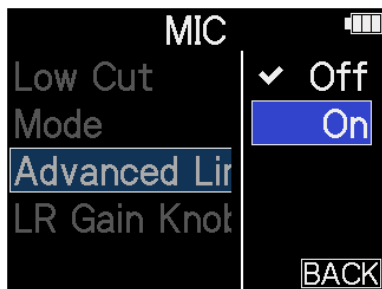

4. Use the  (selection) dial to select "On" or "Off" and press the  (ENTER) button.

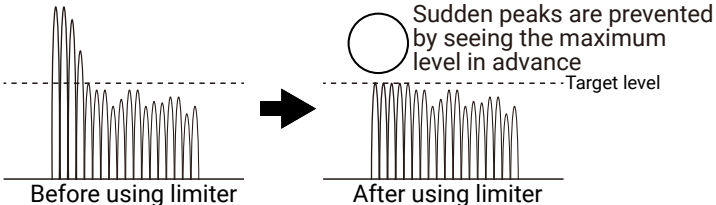

Setting value	Explanation
Off	This disables the limiter.
On	<p>This limiter is optimized to prevent distortion by detecting the maximum level in advance.</p> <p>The ratio is $\infty:1$, providing increased internal headroom.</p> 

Linking L and R gain for the SSH-6e

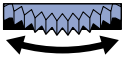
The gain of the mid and side mics can be set to be linked.

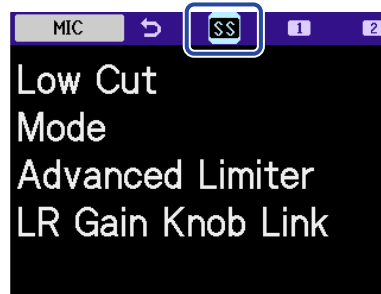

1. On the [Home Screen](#), use the  (selection) dial to select  (INPUT) and press the  (ENTER) button.
This opens the [Input Settings Screen](#).

2. Use the  (selection) dial to select  (MIC) and press the  (ENTER) button.

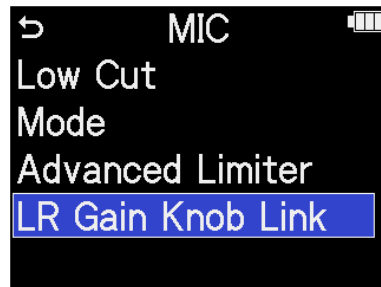

3. Use the  (selection) dial to select "LR Gain Knob Link" and press the  (ENTER) button.

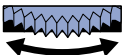

4. Use the  (selection) dial to select "On" or "Off" and press the  (ENTER) button.

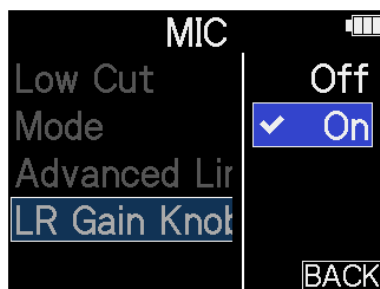

Setting value	Explanation
Off	The gain of the mid and side mics will not be linked. The left MIC GAIN knob adjusts the gain for the mid mic and the right MIC GAIN knob adjusts the gain for the side mic.
On	The gain of the mid and side mics will be linked. The gain set with the left MIC GAIN knob is applied to both the mid and side mics.

Using an EXH-6e

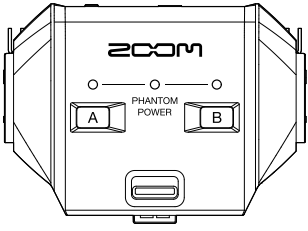

The EXH-6e XLR/TRS combo capsule adds 2 channels of external input. Signals can be input from dynamic mics, line level instruments, mixers and audio players, for example. Phantom power supply is supported, so condenser mics can also be used. In addition, a stereo mini MIC/LINE input jack is built in and supports plug-in power.

NOTE

- When connecting condenser mics and other devices that require phantom power, use an external power supply.

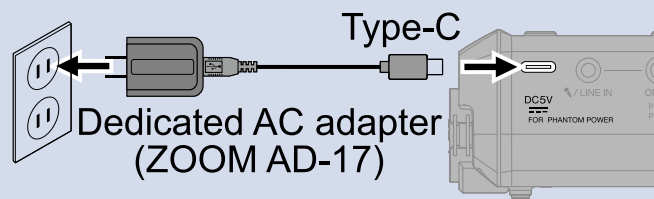

- When connecting a mic that requires plug-in power to the MIC/LINE jack, set the PLUG-IN POWER ON/OFF switch to ON.
- For additional details about the EXH-6e, see its manual.
Download the EXH-6e manual from the ZOOM website (zoomcorp.com/help/exh-6e).

Enabling the EXH-6e inputs

INPUT A and INPUT B of the EXH-6e need to be enabled for use.

- 1.** Press the INPUT A/B buttons.
This will enable that input jack and light the INPUT A/B status indicator.

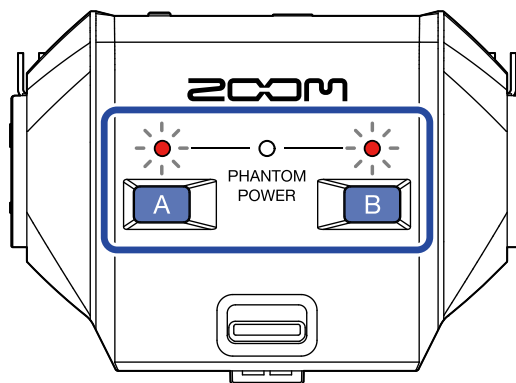

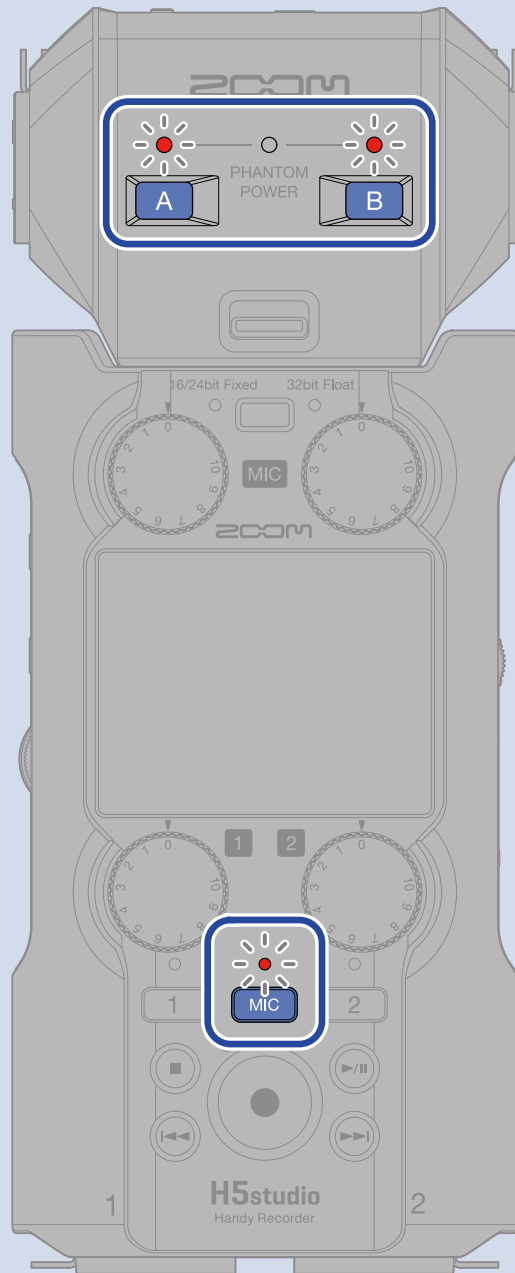

NOTE

To record sound input from an EXH-6e, the mic capsule track must be enabled on the H5studio itself. Confirm that the mic capsule track indicator on the H5studio is lit.



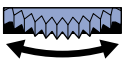

Setting EXH-6e stereo linking

By stereo-linking the EXH-6e inputs, their signals can be handled as stereo audio.

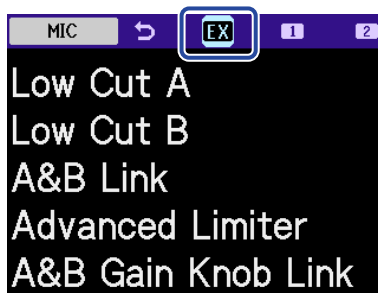

1. On the [Home Screen](#), use the  (selection) dial to select  (INPUT) and press the  (ENTER) button.
This opens the [Input Settings Screen](#).

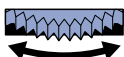
2. Use the  (selection) dial to select  (MIC) and press the  (ENTER) button.

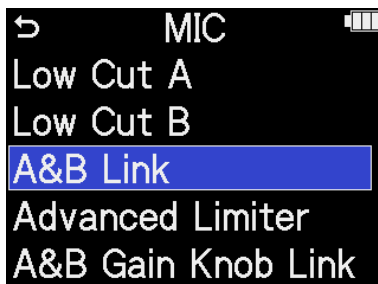

3. Use the  (selection) dial to select "A&B Link" and press the  (ENTER) button.

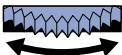

4. Use the  (selection) dial to select the desired item to set and press the  (ENTER) button.

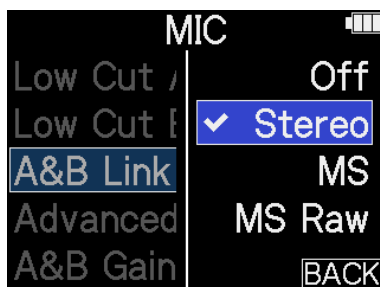

Setting	Explanation
Off	Input signals will be handled as mono audio.
Stereo	The two EXH-6e input signals will be handled as stereo audio. INPUT A will become the L channel and INPUT B will become the R channel.
MS	The two EXH-6e input signals will be handled as stereo audio captured in mid-side format. Audio will be recorded using mid-side processing with INPUT A as the mid and INPUT B as the side.
MS Raw	The two EXH-6e input signals will be handled as stereo audio captured in mid-side format. Mid audio and side audio will be recorded separately as left and right channels in a stereo file before mid-side processing. This setting is useful for changing the side level during post-production after recording.

HINT



Use the MIC GAIN knobs to adjust the mid-side balance.

Use the left MIC GAIN knob to adjust the mid (INPUT A) and the right MIC GAIN knob to adjust the side (INPUT B).

Before doing this, set A&B Gain Knob Link to Off. (→ [Linking A and B gain for the EXH-6e](#))

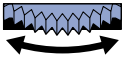

Reducing noise when using an EXH-6e (Low Cut)

Low frequencies can be cut to reduce the sound of wind and vocal pop noises, for example.

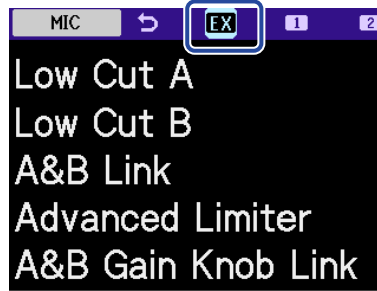

1. On the [Home Screen](#), use the  (selection) dial to select  (INPUT) and press the  (ENTER) button.
This opens the [Input Settings Screen](#).

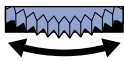
2. Use the  (selection) dial to select  (MIC) and press the  (ENTER) button.

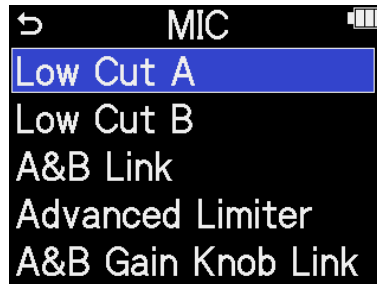

3. Use the  (selection) dial to select "Low Cut A" or "Low Cut B" and press the  (ENTER) button.

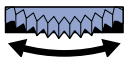

4. Use the  (selection) dial to select the cut frequency and press the  (ENTER) button.

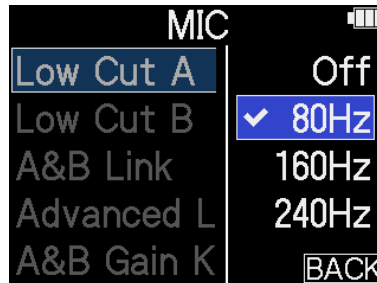



Lo Cut can be set to OFF, 80 Hz, 160 Hz or 240 Hz.

Setting the Advanced Limiter for the EXH-6e

The limiter can be turned on/off for the MIC track.



The H5studio limiter can be set to detect the maximum level in advance and is optimized to prevent distortion.

1. On the [Home Screen](#), use the  (selection) dial to select  (INPUT) and press the  (ENTER) button.

This opens the [Input Settings Screen](#).

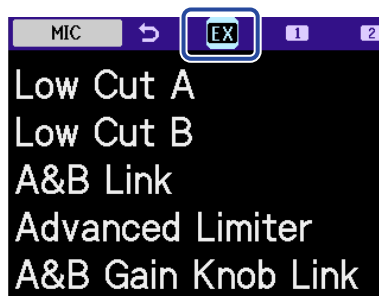
2. Use the  (selection) dial to select  (MIC) and press the  (ENTER) button.

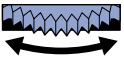

3. Use the  (selection) dial to select "Advanced Limiter" and press the  (ENTER) button.

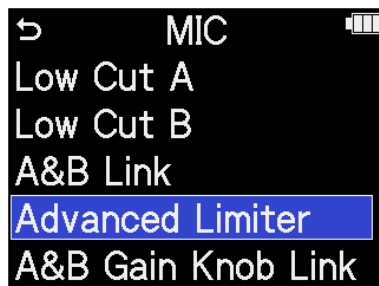

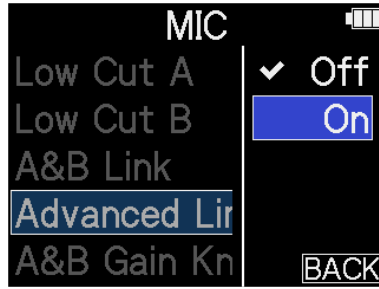

4. Use the  (selection) dial to select "On" or "Off" and press the  (ENTER) button.

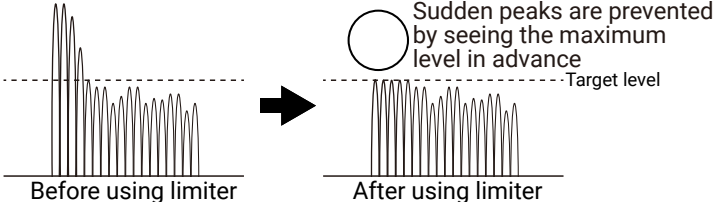

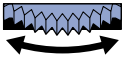

Setting value	Explanation
Off	This disables the limiter.
On	<p>This limiter is optimized to prevent distortion by detecting the maximum level in advance.</p> <p>The ratio is $\infty:1$, providing increased internal headroom.</p> <div style="display: flex; align-items: center; justify-content: center;">  </div> <p style="text-align: center;">Before using limiter After using limiter</p>

Linking A and B gain for the EXH-6e

The gain of INPUT A and INPUT B can be set to be linked.

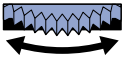

1. On the [Home Screen](#), use the  (selection) dial to select  (INPUT) and press the  (ENTER) button.
This opens the [Input Settings Screen](#).

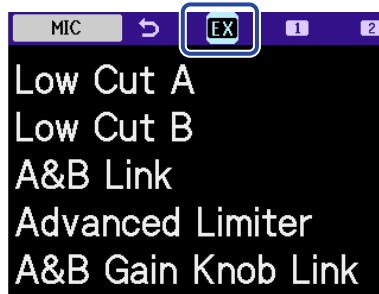
2. Use the  (selection) dial to select  (MIC) and press the  (ENTER) button.

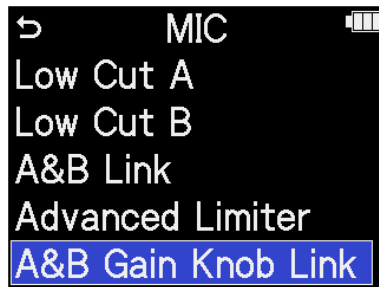

3. Use the  (selection) dial to select "A&B Gain Knob Link" and press the  (ENTER) button.

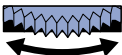

4. Use the  (selection) dial to select "On" or "Off" and press the  (ENTER) button.

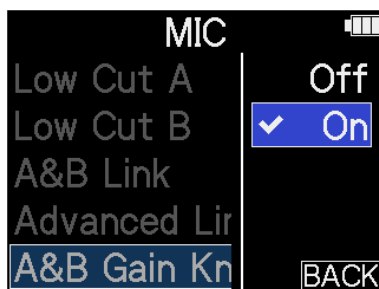

Setting value	Explanation
Off	The gain of INPUT A and INPUT B will not be linked. The left MIC GAIN knob adjusts the gain for INPUT A and the right MIC GAIN knob adjusts the gain for INPUT B.
On	The gain of the mid and side mics will be linked. The gain set with the left MIC GAIN knob is applied to both INPUT A and INPUT B.

Appendix

Troubleshooting

If the H5studio seems to be operating strangely, check the following items first.

Recording/playback trouble

There is no sound or it is very quiet

- Check the orientation of the mic or the volume settings of the connected equipment.
- Confirm that the headphone volume and line output level are not too low. (→ [Monitoring input sounds](#))
- Plug-in power must be supplied if the mic connected to the MIC/LINE IN jack supports plug-in power. (→ [Connecting a lavalier mic, for example, to the MIC/LINE IN jack](#))
- Check the H5studio input settings. (→ [Enabling tracks for recording](#), [Converting mic capsule input to mono](#), [Enabling stereo linking](#))
- Check the phantom power setting. (→ [Setting phantom power](#))
- Check the input volume settings. (→ [Adjusting input gain](#))
- Check the mixer settings during playback. (→ [Adjusting the track level balance](#))
- Confirm that a cable is connected properly to the headphone or line output. If sound is not output even when cables are connected properly, wires in the cables might be broken. Replace the headphones or cable.
- Confirm that the cables connecting the other device and the INPUT 1/2 jacks or MIC/LINE IN jack are connected properly. If sound is not output even when cables are connected properly, wires in the cables might be broken. Replace the cables.

Monitored sound is distorted

- Use the  (VOLUME) dial to adjust the volume.
🔊 VOLUME
- Adjust the input volume settings. (→ [Setting the input level \(mic/line\)](#))

“MIC INPUT OVERLOAD!” or “INPUT 1 (2) OVERLOAD!” appears

- The input sound is too loud. Increase the distance between the mic and the sound source.
- Wind can also cause loud noises to be input. We recommend using the Low Cut setting to reduce noise if air is blown directly at the mic, for example, when recording outdoors or when the mic is near the mouth of a speaker. (→ [Reducing noise \(Low Cut\)](#))

Recording is not possible

- Confirm that the REC button is lit red. (→ [Recording](#))

- Confirm that the microSD card has open space. The available recording time can be checked on screen when recording is paused. (→ [Home Screen](#))
- Confirm that a microSD card is loaded properly in the card slot. (→ [Inserting microSD cards](#))
- Confirm that the input setting is not “Off”. (→ [Enabling tracks for recording](#))
- Check the input volume settings. (→ [Adjusting the overall level balance](#))
- Check the mixer settings during playback. (→ [Adjusting the track level balance](#))

The recorded sound breaks up

- Use the card testing function on the unit and use a card that passes the test.
- We recommend using microSD cards that have been confirmed to operate with this recorder. See the ZOOM website (zoomcorp.com/help/h5studio).

Operation is not possible

-  Confirm that the POWER/HOLD switch is not set to HOLD.

Other trouble

Not recognized by a computer, smartphone or tablet even though the USB port is connected to it

- Use a USB cable that supports data transfer.
- The operation mode must be set on the H5studio to allow the computer, smartphone or tablet to recognize it. (→ [Using as an audio interface](#), [Transferring files to computers and other devices](#))
- Confirm that the computer, smartphone or tablet and the application being used are compatible with 32-bit float format.
- Even if “H5studio” cannot be selected for the “Sound” setting on a computer, it can still be used as a 32-bit float audio interface by selecting “H5studio” as the “Audio” or “Input/Output” device in an application that supports 32-bit float format.
- A driver is necessary to use 32-bit float format with Windows. The driver can be downloaded from the ZOOM website (zoomcorp.com/help/h5studio).

Battery operation time is short

Making the following settings could increase the battery operation time.

- Set the type of batteries used correctly. (→ [Setting the type of batteries used](#))
- Turn off inputs that are not used. (→ [Enabling tracks for recording](#))
- Set the display to dim when not operated for a specific amount of time. (→ [Setting display power saving](#))
- Reduce the display brightness. (→ [Setting the display brightness](#))
- Reduce the sample rate used to record files. (→ [Setting the sample rate](#))
- Disconnect unnecessary cables from the headphone and LINE OUT jacks.
- Due to their characteristics, using rechargeable nickel metal hydride batteries (especially high-capacity ones) or lithium batteries should enable longer use than alkaline batteries when power consumption is high.

An accessibility update is recommended

- Use the latest accessibility installation file to update. (→ [Installing guide sounds](#))

H5studio metadata list

Metadata contained in BEXT chunks in WAV files

Tag	Explanation	Remarks
zSPEED=	Frame rate	
zTAKE=	Take number	
zUBITS=	User bits	
zSCENE=	Scene name	System > Date/Time
zTAPE=		
zCIRCLED=		
zTRKn=	Track name	
zNOTE=		

Metadata contained in iXML chunks in WAV files

○ = YES × = NO

iXML master tag	iXML sub tag	Written	Read	Remarks
<PROJECT>		○	×	
<SCENE>		○	○	System > Date/Time
<TAKE>		○	×	
<TAPE>		○	×	
<CIRCLED>		○	×	
<WILD TRACK>		×	×	
<FALSE START>		×	×	
<NO GOOD>		×	×	
<FILE UID>		○	×	
<UBITS>		○	×	
<NOTE>		○	×	
<BEXT>		×	×	
<USER>		×	×	

iXML master tag	iXML sub tag	Written	Read	Remarks
<SPEED>				
<SPEED>	<NOTE>	○	×	
<SPEED>	<MASTER_SPEED>	○	×	
<SPEED>	<CURRENT_SPEED>	○	×	
<SPEED>	<TIMECODE_RATE>	○	×	
<SPEED>	<TIMECODE_FLAG>	○	×	
<SPEED>	<FILE_SAMPLE_RATE>	○	○	Rec Settings > Sample Rate
<SPEED>	<AUDIO_BIT_DEPTH>	○	×	
<SPEED>	<DIGITIZER_SAMPLE_RATE>	○	×	Rec Settings > Sample Rate
<SPEED>	<TIMESTAMP_SAMPLES_SINCE_MIDNIGHT_HI>	○	×	
<SPEED>	<TIMESTAMP_SAMPLES_SINCE_MIDNIGHT_LO>	○	×	
<SPEED>	<TIMESTAMP_SAMPLE_RATE>	○	×	Rec Settings > Sample Rate

iXML master tag	iXML sub tag	Written	Read	Remarks
<SYNC_POINT_LIST>				
<SYNC_POINT>	<SYNC_POINT_TYPE>	x	x	
<SYNC_POINT>	<SYNC_POINT_FUNCTION>	x	x	
<SYNC_POINT>	<SYNC_POINT_COMMENT>	x	x	
<SYNC_POINT>	<SYNC_POINT_LOW>	x	x	
<SYNC_POINT>	<SYNC_POINT_HIGH>	x	x	
<SYNC_POINT>	<SYNC_POINT_EVENT_DURATION>	x	x	

iXML master tag	iXML sub tag	Written	Read	Remarks
<HISTORY>				
<HISTORY>	<ORIGINAL_FILENAME>	○	x	
<HISTORY>	<PARENT_FILENAME>	x	x	
<HISTORY>	<PARENT_UID>	x	x	

iXML master tag	iXML sub tag	Written	Read	Remarks
<FILE_SET>				
<FILE_SET>	<TOTAL_FILES>	○	x	
<FILE_SET>	<FAMILY_UID>	○	x	
<FILE_SET>	<FAMILY_NAME>	x	x	
<FILE_SET>	<FILE_SET_START_TIME_HI>	x	x	
<FILE_SET>	<FILE_SET_START_TIME_LO>	x	x	
<FILE_SET>	<FILE_SET_INDEX>	○	x	

iXML master tag	iXML sub tag	Written	Read	Remarks
<TRACK_LIST>				
<TRACK_LIST>	<TRACK_COUNT>	○	x	
<TRACK>	<CHANNEL_INDEX>	○	x	
<TRACK>	<INTERLEAVE_INDEX>	○	x	
<TRACK>	<NAME>	○	x	
<TRACK>	<FUNCTION>	x	x	

Mixer block diagrams

When recording or in recording standby

INPUT BLOCK

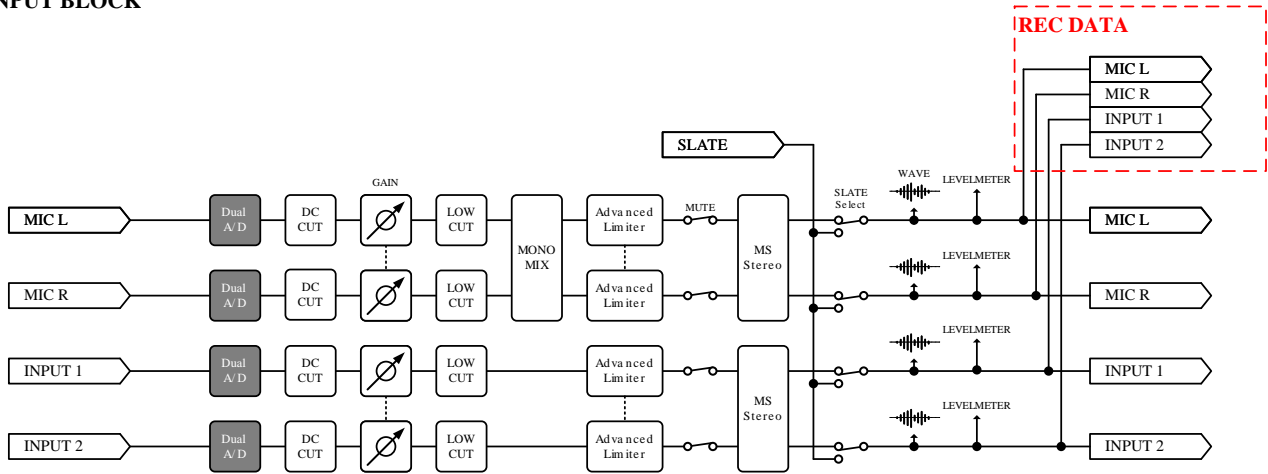

MIXER BLOCK

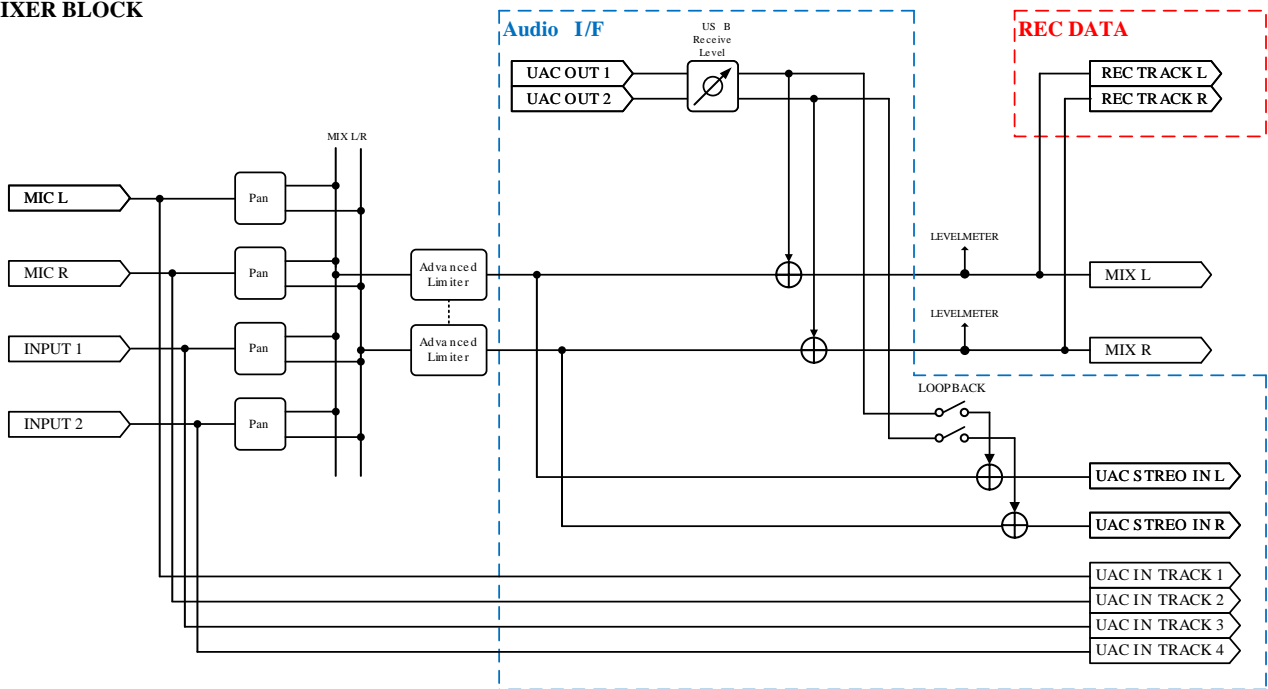

OUTPUT BLOCK

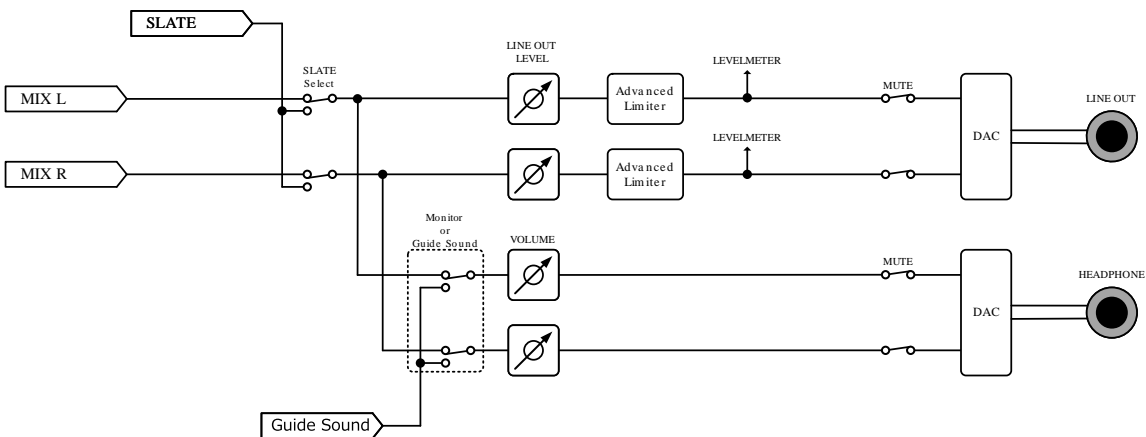

During playback

INPUT BLOCK

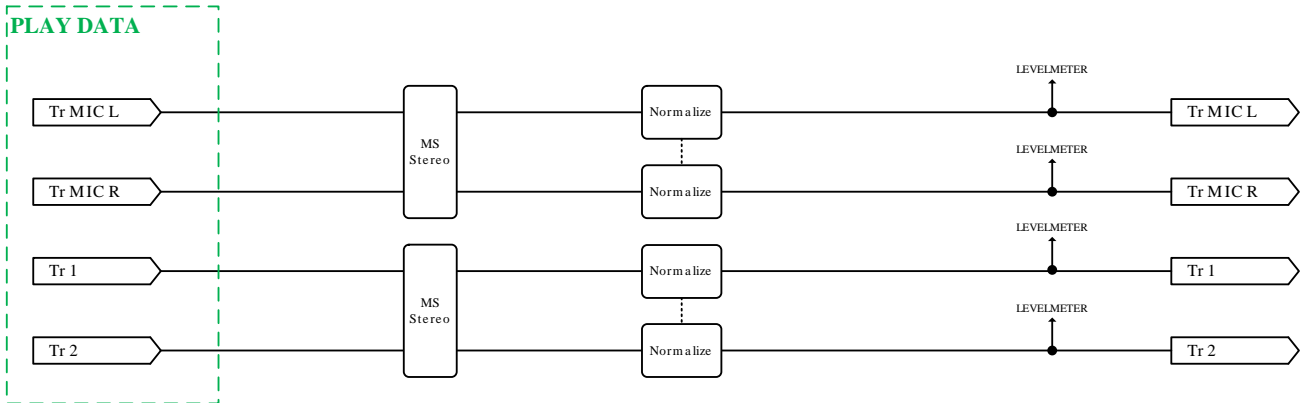

MIXER BLOCK

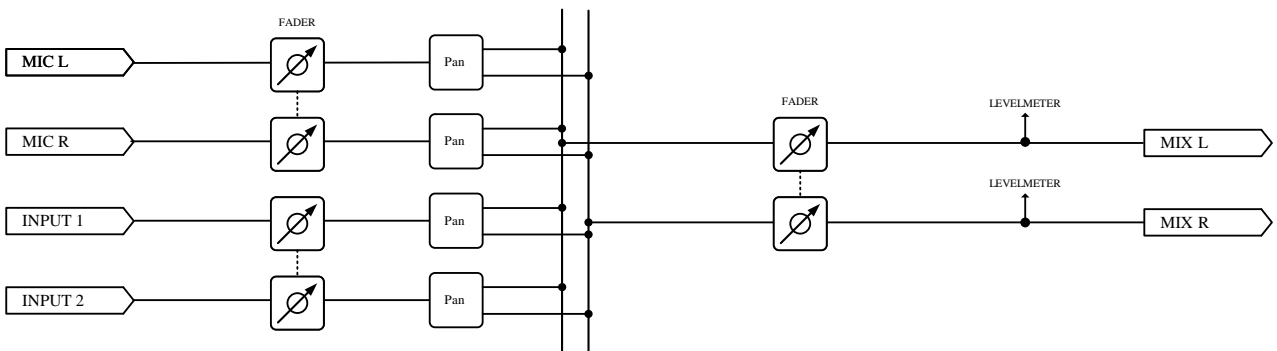

OUTPUT BLOCK

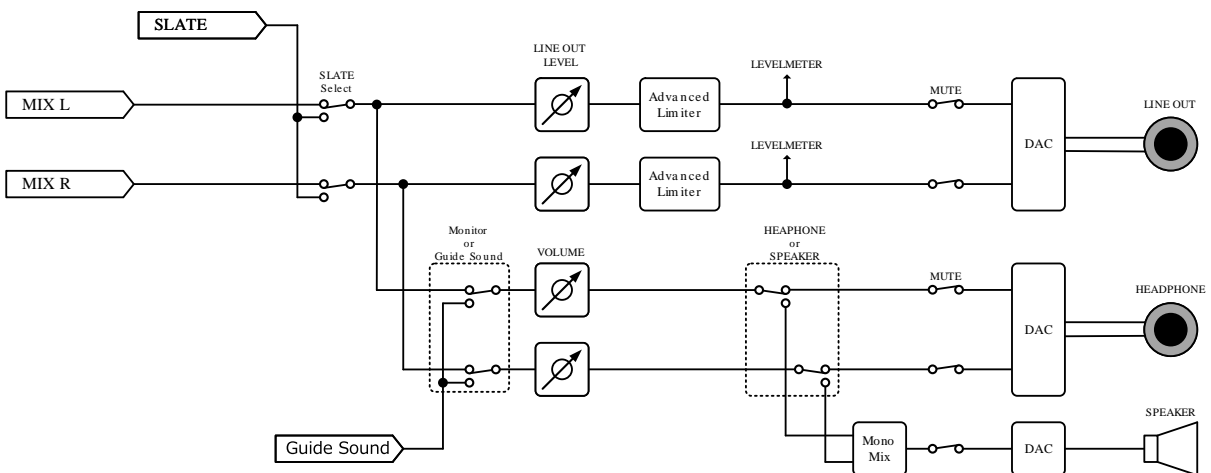

Specifications

Input and output channels	Inputs	Mic capsule	1
		MIC/LINE (mono)	2
	Outputs	LINE OUT	1
		Headphone	1
Built-in speaker (mono)		1	
Inputs	XY mic: XYH-5s	90° XY stereo format	
		Pickup pattern	Unidirectional
		Sensitivity	-41 dB/Pa at 1 kHz
		Maximum sound pressure input	140 dB SPL
	🔊 /LINE IN: XYH-5s	Connector	1 stereo mini jack
		Input gain	-∞ - +60 dB
		Input impedance	2 kΩ or more
	MIC/LINE (mono)	Connectors	2 XLR/TRS combo jacks (XLR: 2 HOT, TRS: TIP HOT)
		Input gain	-∞ - +60 dB
		Input impedance	MIC: 3 kΩ or more LINE: 3 kΩ or more
		Maximum input level	MIC: +4 dBu LINE: +24 dBu
		Phantom power	+48 V
		Equivalent input noise	-127 dBu or less (IHF-A) at 150Ω input
Outputs	LINE OUT	Connector	1 stereo mini jack
		Maximum output level	+1 dBu
		Output impedance	110 Ω or less
	Headphone	Connector	1 stereo mini jack
		Maximum output level	20 mW + 20 mW (when 32 Ω load)
		Output impedance	10 Ω or less
	Built-in speaker	Type	20 mm × 30 mm elliptical dynamic speaker
		Effective maximum output	250 mW
	Recorder		Maximum simultaneous recording tracks

	Maximum simultaneous playback tracks	4
	Recording formats	WAV 44.1/48/96/192 kHz 16-bit/24-bit/32-bit float mono/stereo BWF and iXML formats supported
	Recording media	microSDHC memory cards microSDXC memory cards See the ZOOM website (zoomcorp.com/help/h5studio) for information about microSD cards that have been confirmed to work with this unit.
Display		2.00" full-color LCD (320 × 240)
USB	Connector	USB Type-C • Use a USB cable that supports data transfer. USB bus power is supported.
	Audio interface	USB 2.0 High Speed
	Input and output channels	4 in / 2 out (Multi) 2 in / 2 out (Stereo)
	Sampling frequencies	44.1/48/96 kHz (audio interface only) 44.1/48 kHz (audio interface + onboard recording)
	Bit depths	24-bit, 32-bit float
	File transfer	USB 2.0 High Speed
REMOTE		Dedicated wireless adapter (ZOOM BTA-1)
Power		4 AA batteries (alkaline, lithium or rechargeable NiMH batteries) AC adapter (ZOOM AD-17): DC 5V/1A • USB bus power is supported.
Estimated continuous operation times using batteries • These values are approximate. • Continuous battery operation times were determined using in-house testing methods. They will vary greatly according to use conditions.	2-track (XYH-5s) recording at 48 kHz/32-bit float with phantom power off, no headphones, no LINE OUT, no REMOTE, Power Saving on, Display Brightness Medium	Alkaline batteries: about 15 hours NiMH batteries (1900 mAh): about 13 hours Lithium batteries: about 21 hours

	4-track (XYH-5s and inputs 1-2) recording at 48 kHz/32-bit float with phantom power off, headphones used (33Ω load), no LINE OUT, no REMOTE, Power Saving on, Display Brightness Medium	Alkaline batteries: about 6 hours NiMH batteries (1900 mAh): about 6 hours Lithium batteries: about 11.5 hours
Power consumption		5 W maximum
Dimensions		86.0 mm (W) × 206.0 mm (D) × 54.6 mm (H)
Weight (including batteries)		410 g

Note: 0 dBu = 0.775 Vrms



ZOOM CORPORATION

4-4-3 Kanda-surugadai, Chiyoda-ku, Tokyo 101-0062 Japan

zoomcorp.com