



**IZA 190-HZ**  
**IZA 250-LZ**  
**ZA 190-HZ**  
**ZA 250-LZ**

# FreeSpace®

Integrated Zone Amplifier/Zone Amplifier

Installation and Operating Guide

Installations- og betjeningsvejledning

Installations- und Bedienungsanleitung

Guía de instalación y funcionamiento

Guide d'installation et d'utilisation

Manuale di installazione e funzionamento





Installatie- en bedieningshandleiding

Bruksanvisning för installation och användning





- \* For use by professional installers only
- \* Kun beregnet til at anvendes af professionelle installatører
- \* Nur zur Verwendung durch einen fachkundigen Monteur
- \* Solo apto para instaladores profesionales
- \* Réservé à un technicien professionnel
- \* L'utilizzo è riservato agli installatori professionisti
- \* Uitsluitend bestemd voor professionele installateurs
- \* Endast för professionella användare



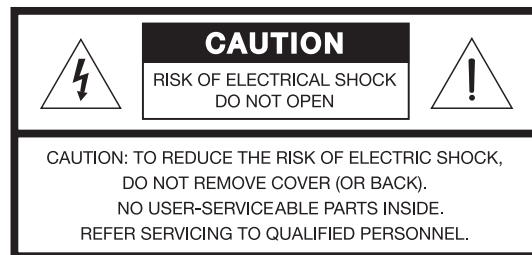

<b>Safety Information</b> .....	<b>4</b>
Introduction .....	20
FreeSpace® IZA 190-HZ/IZA 250-LZ integrated zone amplifier .....	20
Contents .....	20
Front-panel .....	20
Rear-panel .....	21
Loudspeaker connections .....	21
Making loudspeaker connections (IZA 190-HZ) .....	21
Making loudspeaker connections (IZA 250-LZ) .....	22
Input connections .....	23
RCA input connections .....	23
Page input connections .....	23
Mic/Line input connections (Front-panel) .....	24
Aux input (Front-panel) .....	24
Remote Control connections .....	25
Remote volume and source selection control .....	25
Mute with standard contact closure .....	25
AC power connection .....	25
Setup – Rear-panel controls .....	26
Operation – Front-panel controls and indicators .....	27
FreeSpace® ZA 190-HZ/250-LZ zone amplifier.....	28
Contents .....	28
Front-panel controls and indicators.....	28
Rear-panel controls .....	28
Expanding an IZA system with a ZA amplifier .....	29
System operation .....	29
Input connections .....	29
Connecting the IZA 190-HZ/250-LZ amplifier to the ZA 190-HZ/250-LZ amplifier .....	29
Connecting the zone amplifier with other products .....	29
Line input connections.....	29
Loudspeaker connections .....	29
Installation and Placement .....	30
Importance of proper ventilation.....	30
Placing on a flat surface .....	30
Installing the feet on the amplifier .....	30
Stacking units .....	30
Mounting in standard rack with Rack Mount Kit Accessory.....	31
Mounting a single amplifier .....	31
Mounting two amplifiers .....	32
Using the rear rack ears for strain relief .....	33
Spacing requirements for rack-mounted amplifiers .....	33
Troubleshooting .....	34
AC Current Draw and Thermal Dissipation Information .....	35
Specifications.....	36
Additional Resources .....	43

-  **This product is intended for installation by professional installers only!** This document is intended to provide professional installers with basic installation and safety guidelines for Bose® FreeSpace® amplifiers in typical fixed-installation systems. Please read this document before attempting installation.
-  **Warning:** All Bose products must be used in accordance with local, state, federal and industry regulations. It is the installer's responsibility to ensure installation of the amplifier is performed in accordance with all applicable codes, including local building codes and regulations. Consult the local authority having jurisdiction before installing this product.
-  **Warning:** To reduce the risk of fire or electrical shock, do not expose the product to rain or moisture.
-  **Caution:** Do not mount the chassis in locations where condensation may occur.
-  **Warning:** Do not expose this apparatus to dripping or splashing, and do not place objects filled with liquids such as vases, on or near the apparatus. As with any electronic products, use care not to spill liquids into any part of the system. Liquids can cause a failure and/or a fire hazard.



-  The lightning flash with arrowhead symbol, within an equilateral triangle, is intended to alert the user to the presence of uninsulated dangerous voltage within the system enclosure that may be of sufficient magnitude to constitute a risk of electrical shock. Do not touch the output terminals while amplifier power is ON. Make all connections with amplifier OFF.
-  The exclamation point within an equilateral triangle, as marked on the system, is intended to alert the user to the presence of important operating and maintenance instructions in this installation guide.
-  **Caution:** This product shall be connected to an AC mains socket outlet with a protective earthing (grounding) connection.
-  **Caution:** Do not place any naked flame sources, such as lighted candles, on or near the apparatus.
-  **Warning:** Contains small parts which may be a choking hazard. Not suitable for children under age 3.
- Note:** The product label is located on the bottom of the product.
- Note:** Where the mains plug or appliance coupler is used as the disconnect device, such disconnect device shall remain readily operable.
- Note:** The product must be used indoors. It is neither designed nor tested for use outdoors, in recreational vehicles, or on boats.
- Note:** When placing the amplifier on a flat surface, use the included feet to ensure proper ventilation. One amplifier can be stacked on top of another when feet are installed on both amplifiers. To install feet, place amplifier upside-down, insert the four feet into the four holes on the bottom of the chassis. To lock each foot into place, press a locking pin into each foot hole.
- Note:** Allow 1RU spacing above and below rack-mounted amplifiers to ensure sufficient spacing for ventilation. Additionally, the temperature of the rack should be controlled to ensure that amplifiers are not exposed to temperatures exceeding 40° C (104° F).

1. Read these instructions.
2. Keep these instructions – for future reference.
3. Heed all warnings – on the product and in all product documentation.
4. Follow all instructions.
5. Do not use this apparatus near water.
6. Clean only with a dry cloth.
7. Do not block any ventilation openings. Install in accordance with the manufacturer's instructions. To ensure reliable operation of the product and to protect it from overheating put the product in a position and location that will not interfere with its proper ventilation.
8. Do not install near any heat sources, such as radiators, heat registers, stoves, or other apparatus (including amplifiers) that produce heat.
9. Do not defeat the safety purpose of the polarized or grounding-type plug. A polarized plug has two blades with one wider than the other. A grounding-type plug has two blades and a third grounding prong. The wider blade or third prong is provided for your safety. If the provided plug does not fit in your outlet, consult an electrician for replacement of the obsolete outlet.
10. Protect the power cord from being walked on or pinched, particularly at plugs, convenience receptacles, and the point where they exit from the apparatus.
11. Only use attachments/accessories specified by the manufacturer.
12.  Use only with the cart, stand, tripod, bracket, or table specified by the manufacturer or sold with the apparatus. When a cart is used, use caution when moving the cart/apparatus combination to avoid injury from tip-over.
13. Unplug this apparatus during lightning storms or when unused for long periods of time to prevent damage to this product.
14. Refer all servicing to qualified service personnel. Servicing is required when the apparatus has been damaged in any way such as power-supply cord or plug is damaged; liquid has been spilled or objects have fallen into the apparatus; the apparatus has been exposed to rain or moisture, does not operate normally, or has been dropped. Do not attempt to service this product yourself. Opening or removing covers may expose you to dangerous voltages or other hazards. Please call Bose to be referred to an authorized service center near you.
15. To prevent risk of fire or electric shock, avoid overloading wall outlets, extension cords, or integral convenience receptacles.
16. Do not let objects or liquids enter the product – as they may touch dangerous voltage points or short-out parts that could result in a fire or electric shock.
17. Do not allow the unit to exceed the maximum operating ambient temperature of 40° C. Be aware of conditions in an enclosed rack that may increase the temperature above room ambient conditions.

 This product conforms to all applicable EU directive requirements. The complete Declaration of Conformity can be found at [www.Bose.com/compliance](http://www.Bose.com/compliance).

**This Product meets the immunity requirements for the E2 class EN55103-2 directive.**

Initial turn on inrush current: 13.9 Amps (230V/50 Hz), 7.6 Amps (120V/60 Hz)

Inrush current after 5 seconds AC mains interruption: 13.9 Amps (230V/50 Hz), 7.5 Amps (120V/60 Hz)

#### **Information About Products That Generate Electrical Noise (FCC Compliance Notice for US)**

**Note:** This equipment has been tested and found to comply with the limits for a Class A digital device, pursuant to part 15 of the FCC Rules. These limits are designed to provide reasonable protection against harmful interference when the equipment is operated in a commercial environment. This equipment generates, uses, and can radiate radio frequency energy and, if not installed and used in accordance with the instruction manual, may cause harmful interference to radio communications. Operation of this equipment in a residential area is likely to cause harmful interference in which case the user will be required to correct the interference at one's own expense.

**This product complies with the Canadian ICES-003 Class A specifications.**

 **Dette produkt er kun beregnet til at anvendes af professionelle installatører!** Dette dokument har til formål at give professionelle installatører grundlæggende installations- og sikkerhedsretningslinjer for Bose® FreeSpace®-forstærkere i typiske systemer med fast installation. Læs venligst dette dokument, inden du forsøger at foretage en installation.

 **Advarsel:** Alle Bose-produkter skal anvendes i overensstemmelse med lokale regler, statslige regler og brancheregler. Det er installatørens ansvar at sikre, at installationen af forstærkeren foretages i overensstemmelse med alle relevante regler, herunder regler og forskrifter for den lokale bygning. Kontakt de lokale myndigheder, inden du installerer dette produkt.

 **Advarsel:** Produktet må ikke udsættes for regn eller fugtighed på grund af risikoen for brand eller elektrisk stød.

 **Forsigtig:** Monter ikke chassiset på steder, hvor der kan blive dannet kondens.

 **Advarsel:** Udsæt ikke dette apparat for dryp eller stænk, og placer ikke genstande, der er fyldt med væske, på eller nær ved apparatet. Som ved alle elektriske apparater skal du passe på ikke at spilde væske på nogen af systemdelene. Væsker kan forårsage fejl i systemet og/eller medføre fare for brand.



 Symbolet med et lyn med pilespids i en ligesidet trekant skal gøre brugeren opmærksom på tilstedeværelsen af en uisoleret farlig spænding i det lukkede system, der kan være tilstrækkelig kraftig til at give elektrisk stød. Rør ikke ved udgangsklemmerne, mens forstærkeren er tændt. Foretag alle tilslutninger, mens forstærkeren er slukket.

 En ligebeinet trekant med et udråbstegn, som markeret på systemet, skal henlede brugerens opmærksomhed på vigtige betjenings- og vedligeholdelsesinstruktioner i denne installationsvejledning.

 **Forsigtig:** Dette produkt skal tilsluttes en stikkontakt med en beskyttende jordforbindelse.

 **Forsigtig:** Placer ikke nogen form for åben ild (f.eks. stearinlys) på eller tæt ved apparatet.

 **Advarsel:** Indeholder små dele, som kan udgøre en kvælningfare. Egner sig ikke til børn under 3 år.

**Bemærk:** Produktmærkaten er placeret i bunden af produktet.

**Bemærk:** Hvis netstikket eller apparatets tænd/sluk-knap anvendes som afbryder, skal denne afbryder være let at komme til.

**Bemærk:** Produktet skal anvendes inden døre. Det er hverken designet eller testet til udendørs brug i fritidskøretøjer eller i lystbåde.

**Note:** When placing the amplifier on a flat surface, use the included feet to ensure proper ventilation. One amplifier can be stacked on top of another when feet are installed on both amplifiers. To install feet, place amplifier upside-down, insert the four feet into the four holes on the bottom of the chassis. To lock each foot into place, press a locking pin into each foot hole.

**Note:** Allow 1RU spacing above and below rack-mounted amplifiers to ensure sufficient spacing for ventilation. Additionally, the temperature of the rack should be controlled to ensure that amplifiers are not exposed to temperatures exceeding 40° C (104° F).

1. Læs disse instruktioner.
2. Gem disse instruktioner – til senere brug.
3. Følg alle advarsler – på produktet og i al produktdokumentation.
4. Følg alle instruktioner.
5. Anvend ikke dette apparat i nærheden af vand.
6. Rengør kun med en tør klud.
7. Undgå at blokere ventilationsåbningerne. Installer i overensstemmelse med producentens instruktioner. For at sikre pålidelig funktion og beskytte mod overophedning skal produktet anbringes i en position og på et sted, der ikke hindrer korrekt ventilation.
8. Installer ikke produktet i nærheden af varmekilder som f.eks. radiatorer, varmeovne, komfurer eller andre apparater (herunder forstærkere), der producerer varme.
9. Omgå ikke sikkerheden ved brug af et ikke-jordforbundet stik. Et polariseret stik har to stikben, hvor det ene er bredere end det andet. Et jordforbundet stik har to ben og et tredje jordben. Det brede ben eller tredje ben er der for din sikkerhed. Hvis det medfølgende stik ikke passer i stikkontakten, skal du kontakte en elektriker for at få stikkontakten udskiftet.
10. Beskyt netledningen mod at blive trådt på eller klemt, især ved stikkene, stikkontakter og på det sted, hvor den kommer ud af apparatet.
11. Brug kun tilslutningsudstyr/tilbehør, der er angivet af producenten.
12.  Brug kun apparatet sammen med en vogn, et stativ, et beslag eller et bord, der er angivet af producenten eller solgt sammen med apparatet. Når der anvendes en vogn, skal der udvises forsigtighed ved kørsel med vogn/apparat, så det ikke vælter og forårsager kvæstelser.
13. Afbryd strømforsyningen til apparatet under tordenvejr, eller når det ikke skal bruges i en længere periode, for at forhindre skade på produktet.
14. Overlad al servicering til kvalificeret servicepersonale. Et serviceeftersyn er påkrævet, når apparatet på nogen måde er beskadiget – hvis f.eks. netledningen eller strømstikket er beskadiget; der er blevet spildt væske; der er kommet genstande ind i apparatet; hvis apparatet er blevet udsat for regn eller fugt, ikke virker normalt eller er blevet tabt – forsøg ikke at servicere dette produkt selv. Åbning eller fjernelse af dæksler kan udsætte dig for farlige spændinger eller andre risici. Kontakt Bose for at få oplysninger om det nærmeste servicecenter.
15. Undgå at overbelaste stikkontakter, forlængerledninger eller indbyggede stik af hensyn til risikoen for brand eller elektrisk stød.
16. Sørg for, at genstande eller væske ikke kommer ind i produktet – da sådanne kan komme i berøring med steder med farlig spænding eller kortslutte dele, hvilket kan resultere i brand eller elektrisk stød.
17. Chassiset må have en maksimal driftstemperatur på 40 °C. Vær opmærksom på, at forholdene i et lukket rack kan øge temperaturen over omgivelsestemperaturen.

 Dette produkt overholder alle EU-direktivkrav i henhold til gældende lov. Den fulde overensstemmelseserklæring finder du på [www.Bose.com/compliance](http://www.Bose.com/compliance).

**Dette produkt lever op til immunitetskravene for direktivet E2 klasse EN55103-2.**

Initialt startstrømstød, når enheden tændes: 13.9 ampere (230V/50 Hz), 7.6 ampere (120V/60 Hz)

Startstrømstød efter 5 sekunders afbrydelse af lysnetstrømmen: 13.9 ampere (230V/50 Hz), 7.5 ampere (120V/60 Hz)

**Oplysninger om produkter, der genererer elektrisk støj (meddelelse om FCC-overensstemmelse for USA)**

**Bemærk:** Dette udstyr er blevet testet og overholder grænserne for en digital enhed i klasse A i henhold til del 15 af FCC-reglerne. Disse grænser er udviklet til at yde rimelig beskyttelse mod skadelig interferens, når udstyret anvendes i en professionel installation. Dette udstyr genererer, bruger og kan udstråle radiofrekvensenergi, og kan – hvis det ikke installeres og bruges i overensstemmelse med brugervejledningen – forårsage skadelig interferens i forbindelse med radiokommunikation. Brug af dette udstyr i en privat installation kan forårsage skadelig interferens, og i så fald må brugeren få udbedret interferensen for egen regning.

**Dette produkt overholder de canadiske ICES-003 Klasse A-specifikationer.**

 **Dieses Produkt darf nur von fachkundigen Monteuren installiert werden!** Dieses Dokument soll fachkundigen Monteuren grundlegende Installations- und Sicherheitsrichtlinie für Bose® FreeSpace®-Verstärker in typischen Festinstallationssystemen bieten. Bitte lesen Sie dieses Dokument vor der Installation durch.

 **Warnung:** Alle Bose-Produkte müssen gemäß den örtlichen und staatlichen Vorschriften sowie gemäß allen Branchenbestimmungen verwendet werden. Der Monteur ist dafür verantwortlich, sicherzustellen, dass die Installation des Verstärkers gemäß allen geltenden Vorschriften durchgeführt wird, einschließlich örtlicher Bauvorschriften und Bestimmungen. Wenden Sie sich vor der Installation dieses Produkts an die zuständige Abnahmebehörde.

 **Warnung:** Um Brände und Stromschläge zu vermeiden, darf dieses Produkt weder Regen noch Feuchtigkeit ausgesetzt werden.

 **Achtung:** Montieren Sie das Gehäuse nicht an Orten, an denen Kondensation auftreten kann.

 **Warnung:** Schützen Sie das Gerät vor tropfenden oder spritzenden Flüssigkeiten, und stellen Sie keine mit Flüssigkeiten gefüllten Gefäße (z. B. Vasen) auf das Gerät oder in die Nähe des Geräts. Wie bei allen elektronischen Geräten dürfen niemals Flüssigkeiten ins Innere gelangen. Dadurch kann es zu Fehlfunktionen oder Bränden kommen.

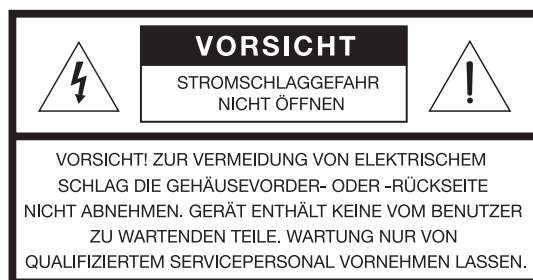

 Das Blitzsymbol mit Pfeilspitze in einem gleichseitigen Dreieck weist den Benutzer auf das Vorhandensein einer nicht isolierten gefährlichen elektrischen Spannung innerhalb des Systemgehäuses hin, durch die die Gefahr von Stromschlägen besteht. Berühren Sie die Ausgangsanschlüsse nicht, wenn der Verstärker eingeschaltet ist. Schalten Sie alle Anschlüsse am Verstärker aus.

 Das Ausrufezeichen in einem gleichseitigen Dreieck, wie es am System angebracht ist, soll den Benutzer auf wichtige Bedienungs- und Wartungsanweisungen in dieser Installationsanleitung aufmerksam machen.

 **Achtung:** Dieses Produkt muss an eine Steckdose mit Erdungsschutz angeschlossen werden.

 **Achtung:** Stellen Sie keine brennenden Kerzen oder ähnliches auf das Gerät oder in die Nähe des Geräts.

 **Warnung:** Enthält kleine Teile, die verschluckt werden können und eine Erstickungsgefahr darstellen. Nicht geeignet für Kinder unter drei Jahren.

**Hinweis:** Das Etikett mit der Produktbezeichnung befindet sich auf der Unterseite des Geräts.

**Hinweis:** Falls Sie den Netzstecker oder eine Mehrfachsteckdose verwenden, um das Gerät von der Stromversorgung zu trennen, sollten Sie sicherstellen, dass Sie jederzeit auf den Stecker zugreifen können.

**Hinweis:** Das Produkt ist nicht zum Einsatz im Freien geeignet. Verwenden Sie es nur innerhalb von Gebäuden und nicht in Campingfahrzeugen, auf Booten o. ä.

**Note:** When placing the amplifier on a flat surface, use the included feet to ensure proper ventilation. One amplifier can be stacked on top of another when feet are installed on both amplifiers. To install feet, place amplifier upside-down, insert the four feet into the four holes on the bottom of the chassis. To lock each foot into place, press a locking pin into each foot hole.

**Note:** Allow 1RU spacing above and below rack-mounted amplifiers to ensure sufficient spacing for ventilation. Additionally, the temperature of the rack should be controlled to ensure that amplifiers are not exposed to temperatures exceeding 40° C (104° F).



**Wichtige Sicherheitshinweise**

1. Lesen Sie die folgenden Anweisungen.
2. Bewahren Sie diese Anweisungen auf – zum späteren Nachschlagen.
3. Beachten Sie alle Warnhinweise – am Produkt und in der gesamten Produktdokumentation.
4. Befolgen Sie alle Anweisungen.
5. Verwenden Sie dieses Gerät nicht in der Nähe von Wasser.
6. Reinigen Sie das Gerät nur mit einem sauberen, trockenen Tuch.
7. Achten Sie darauf, dass die Lüftungsöffnungen nicht blockiert sind. Stellen Sie das Gerät nur in Übereinstimmung mit den Herstelleranweisungen auf – Stellen Sie es nur an einem Ort auf, an dem eine gute Ventilation gewährleistet ist, um den zuverlässigen Betrieb des Geräts sicherzustellen und es gegen Überhitzung zu schützen.
8. Stellen Sie das Gerät nicht in der Nähe von Wärmequellen auf, wie Heizkörper, Wärmespeicher, Öfen oder andere Geräten (auch Verstärker), die Wärme erzeugen.
9. Beeinträchtigen Sie in keiner Weise die Schutzfunktion des Schutzkontaktsteckers. Ein gepolter Stecker hat zwei Stromkontakte, von denen einer breiter als der andere ist. Ein Schutzkontaktstecker hat zwei Stromkontakte und einen dritten Erdungskontakt. Der dritte Kontakt dient der Sicherheit. Falls der mitgelieferte Stecker nicht in Ihre Steckdose passt, wenden Sie sich an einen qualifizierten Elektriker, um die Steckdose auszutauschen.
10. Verlegen Sie das Netzkabel so, dass es keine Stolpergefahr darstellt und nicht beschädigt werden kann – insbesondere im Bereich von Steckern und Steckdosen und dort, wo das Netzkabel aus dem Gerät herausgeführt wird.
11. Verwenden Sie nur Zubehör-/Anbauteile, die vom Hersteller zugelassen sind.
12.  Verwenden Sie für das Gerät nur Rollwagen, Ständer, Dreibeine, Halterungen oder Tische, die vom Hersteller zugelassen sind oder zusammen mit dem Gerät verkauft werden. Falls Sie einen Rollwagen verwenden, dürfen Sie die Einheit Gerät/Rollwagen nur mit Vorsicht bewegen, damit Verletzungen beim möglichen Umkippen ausgeschlossen sind.
13. Ziehen Sie den Netzstecker des Geräts während eines Gewitters oder wenn Sie das Gerät längere Zeit nicht benutzen – zur Vermeidung von Schäden am Produkt.
14. Wenden Sie sich bei allen Reparatur- und Wartungsarbeiten nur an qualifiziertes Kundendienstpersonal. Wartungsarbeiten sind in folgenden Fällen nötig: Bei jeglichen Beschädigungen wie z. B. des Netzkabels oder des Netzsteckers, wenn Flüssigkeiten oder Gegenstände in das Gehäuse gelangt sind, das Gerät Regen oder Feuchtigkeit ausgesetzt wurde, fallen gelassen wurde oder nicht ordnungsgemäß funktioniert – Versuchen Sie in solchen Fällen keinesfalls, das Gerät selbst zu reparieren. Öffnen oder entfernen Sie unter keinen Umständen die Gehäuseabdeckungen, da Sie andernfalls mit gefährlichen elektrischen Spannungen in Berührung kommen oder anderen Gefahren ausgesetzt sein könnten. Wenden Sie sich telefonisch an Bose, um die Anschrift eines autorisierten Kundendienstzentrums in Ihrer Nähe zu erfragen.
15. Vermeiden Sie Gefahren durch Brände oder elektrische Schläge, indem Sie Steckdosen, Verlängerungskabel und integrierte Gerätesteckdosen nicht überlasten.
16. Lassen Sie keine Flüssigkeiten oder Fremdkörper in das Gerät gelangen – sie können unter gefährliche elektrische Spannung gesetzt werden oder Bauteile kurzschließen und folglich Brände und Stromschläge auslösen.
17. Achten Sie darauf, dass die Betriebstemperatur des Geräts 40 °C nicht überschreitet. Seien Sie sich aller Bedingungen in einem geschlossenen Rack bewusst, welche zu einem Anstieg der Temperatur über Zimmerniveau führen können.

 Dieses Produkt erfüllt alle vorgeschriebenen EU-Richtlinien. Die vollständige Konformitätserklärung ist einsehbar unter [www.Bose.com/compliance](http://www.Bose.com/compliance).

**Dieses Produkt erfüllt die Anforderungen an die Störfestigkeit der Klasse E2 der Richtlinie EN55103-2.**





Anfänglicher Einschaltstrom: 13.9 A (230V/50 Hz), 7.6 A (120V/60 Hz)

Einschaltstrom nach 5 Sekunden Unterbrechung des Netzanschlusses: 13.9 A (230V/50 Hz), 7.5 A (120V/60 Hz)





**Informationen über Produkte, die elektrisches Rauschen verursachen (Hinweis zur FCC-Einhaltung für die USA)**

**Hinweis:** Dieses Gerät wurde geprüft. Es stimmt mit den Regelungen für Geräte der Klasse A gemäß Teil 15 der FCC-Vorschriften überein. Diese Grenzwerte sollen einen angemessenen Schutz gegen elektromagnetische Störungen beim Betrieb in gewerblicher Umgebung gewährleisten. Dieses Gerät erzeugt und verwendet Hochfrequenzstrahlung und kann sie auch aussenden. Daher verursacht das Gerät, wenn die Installation und Benutzung nicht in Übereinstimmung mit dieser Bedienungsanleitung erfolgt, möglicherweise Störungen des Funkverkehrs. Beim Betrieb dieses Geräts in Wohngebieten können erhebliche Störungen des Funkverkehrs verursacht werden. Eventuell daraus entstehende Kosten trägt allein der Benutzer des Geräts.

**Dieses Produkt erfüllt die kanadische Richtlinie ICES-003, Klasse A.**

-  **Solo un instalador profesional deberá montar este producto.** Este documento está pensado para ofrecer a los instaladores profesionales instrucciones básicas de instalación y seguridad relacionadas con los amplificadores Bose® FreeSpace® en sistemas típicos de instalaciones fijas. Lea este documento antes de intentar la instalación.
-  **Advertencia:** todos los productos Bose se deben utilizar según lo estipulado en las normativas industriales locales, regionales y nacionales. Será responsabilidad del instalador garantizar que la instalación del amplificador se lleva a cabo según lo dispuesto en los códigos correspondientes, incluidos los códigos de construcción locales y las normativas. Consulte a las autoridades locales pertinentes antes de instalar este producto.
-  **Advertencia:** para reducir el riesgo de incendio o descarga eléctrica, no exponga el producto a lluvia o humedad.
-  **Precaución:** no monte el chasis en lugares donde pueda producirse condensación.
-  **Advertencia:** no exponga este aparato a salpicaduras o goteo. No coloque objetos que contengan líquidos, por ejemplo, jarrones, encima o cerca del aparato. Al igual que con cualquier producto electrónico, evite que se derramen líquidos en los componentes del sistema, ya que pueden provocar averías o riesgo de incendio.



-  El símbolo de relámpago con una flecha dentro de un triángulo equilátero indica al usuario que la caja del sistema puede contener una tensión sin aislar de magnitud suficiente para constituir un riesgo de descarga eléctrica. No toque los terminales de salida mientras el amplificador está encendido. Realice todas las conexiones con el amplificador apagado.
-  El signo de exclamación dentro de un triángulo equilátero, tal como aparece marcado en el sistema, avisa al usuario de que existen instrucciones de operación y mantenimiento importantes en esta guía de instalación.
-  **Precaución:** este producto se puede conectar a una toma de corriente de CA con conexión de protección a tierra (masa).
-  **Precaución:** no coloque llamas vivas, por ejemplo, velas, encima o cerca del aparato.
-  **Advertencia:** contiene piezas pequeñas que pueden suponer riesgo de asfixia. No adecuado para niños de menos de 3 años.
- Nota:** La etiqueta del producto se encuentra en la base del mismo.
- Nota:** Si se utiliza la clavija de red o el conector del aparato como dispositivo de desconexión, deberá poder accionarse fácilmente.
- Nota:** Este producto debe utilizarse en espacios interiores. No está diseñado ni ha sido probado para uso al aire libre ni en embarcaciones.
- Note:** When placing the amplifier on a flat surface, use the included feet to ensure proper ventilation. One amplifier can be stacked on top of another when feet are installed on both amplifiers. To install feet, place amplifier upside-down, insert the four feet into the four holes on the bottom of the chassis. To lock each foot into place, press a locking pin into each foot hole.
- Note:** Allow 1RU spacing above and below rack-mounted amplifiers to ensure sufficient spacing for ventilation. Additionally, the temperature of the rack should be controlled to ensure that amplifiers are not exposed to temperatures exceeding 40° C (104° F).

1. Lea las siguientes instrucciones.
2. Guarde estas instrucciones para consultarlas en el futuro.
3. Respete todas las advertencias que se indican en el producto y en la documentación.
4. Siga todas las instrucciones.
5. No utilice este aparato cerca del agua.
6. Límpielo solo con un trapo seco.
7. No bloquee las aberturas de ventilación. Instálelo siguiendo las instrucciones del fabricante. Para garantizar un funcionamiento fiable del producto y evitar que se recaliente, colóquelo en una ubicación y posición que permitan una ventilación adecuada.
8. No lo instale cerca de fuentes de calor, tales como radiadores, salidas de aire caliente, cocinas u otros aparatos (incluidos amplificadores) que generen calor.
9. No elimine el mecanismo de seguridad del enchufe con toma a tierra o polarizado. Los enchufes polarizados disponen de dos clavijas, una de mayor tamaño que la otra. Los enchufes con toma a tierra tienen dos clavijas y un tercer terminal de tierra. La patilla más ancha y el tercer terminal se incluyen como medida de seguridad. Si el enchufe suministrado no encaja en la toma, póngase en contacto con un electricista para sustituir la toma antigua.
10. Proteja el cable de alimentación de forma que nadie lo pise ni quede pinzado, en particular cerca de enchufes, receptáculos de tomas múltiples y en el lugar en que sale del aparato.
11. Utilice solo conexiones y accesorios suministrados por el fabricante.
12.  Utilícelo solo con el carrito, soporte, trípode, abrazadera o mesa suministrados por el fabricante o incluidos con el dispositivo. Si utiliza un carrito, tenga cuidado al desplazar el conjunto del carrito y el aparato para evitar daños por posibles caídas.
13. Desenchufe el dispositivo si se produce una tormenta eléctrica o si no lo va a utilizar durante periodos prolongados de tiempo para evitar que se dañe.
14. Toda reparación debe ser realizada por personal cualificado. Lleve el dispositivo a reparar si presenta algún daño como, por ejemplo, si el cable de alimentación o el enchufe están dañados, si se han vertido líquidos o se han caído objetos sobre el dispositivo o si éste ha estado expuesto a la lluvia o humedad; si no funciona correctamente o se ha caído al suelo. No intente reparar el producto usted mismo. La apertura o retirada de las tapas le expondrá a tensiones peligrosas o a otros peligros. Póngase en contacto con Bose para conocer cuál es el centro de servicio técnico autorizado de su zona.
15. Para prevenir el riesgo de incendio o descargas eléctricas, evite sobrecargar los enchufes, alargadores o receptáculos de las tomas.
16. Evite que caigan objetos o líquidos sobre el producto, ya que podrían entrar en contacto con puntos de niveles de voltaje altos o partes que podrían sufrir un cortocircuito y causar incendios o descargas eléctricas.
17. No exponga la unidad a temperaturas superiores a 40 °C, su temperatura máxima de funcionamiento. Tenga en cuenta todas las situaciones que pueden darse en un bastidor cerrado y que podrían aumentar la temperatura por encima de las condiciones ambientales de la sala.

**CE** Este producto cumple los requisitos de todas las Directivas de la UE aplicables legalmente. Encontrará la declaración de conformidad completa en [www.Bose.com/compliance](http://www.Bose.com/compliance).

**Este producto cumple los requisitos de inmunidad que establece la Directiva EN55103-2 para la clase E2.**

Corriente inicial de encendido: 13.9 amperios (230V/50 Hz), 7.6 amperios (120V/60 Hz)

Corriente inicial tras 5 segundos de interrupción de suministro de CA: 13.9 amperios (230V/50 Hz), 7.5 amperios (120V/60 Hz)

**Información sobre productos que generan ruido eléctrico (Nota de homologación FCC para EE UU)**

**Nota:** este equipo se ha probado y ha demostrado que cumple con los límites para dispositivos digitales de clase B, de acuerdo con el apartado 15 de las normas de la FCC. Estos límites están diseñados para ofrecer una protección razonable contra las interferencias perjudiciales cuando el aparato se utiliza en un entorno comercial. Este equipo genera, utiliza y puede irradiar energía de radiofrecuencia y, si no se instala y se utiliza de acuerdo con el manual de instrucciones, podría ocasionar interferencias perjudiciales para las comunicaciones por radio. La utilización de este equipo en una zona residencial podría causar interferencias dañinas. En ese caso, la corrección de la interferencia correrá a cargo del usuario.

**Este producto cumple las especificaciones canadienses para dispositivos de clase A ICES-003.**

 **L'installation de ce produit est réservée à un technicien professionnel !** Ce document à l'intention des installateurs professionnels contient les directives de pose et de sécurité relatives aux amplificateurs professionnels Bose® FreeSpace® en installation fixe. Lisez attentivement ce document avant l'installation.

 **Avertissement :** Tous les produits Bose doivent être utilisés en respectant les réglementations locales et nationales. L'installateur est responsable du respect de tous les codes et règlements locaux et nationaux en vigueur applicables à l'installation de l'amplificateur. Consultez les autorités locales compétentes avant d'installer ce produit.

 **Avertissement :** Pour limiter les risques d'incendie ou d'électrocution, n'exposez pas l'appareil à la pluie ou à l'humidité.

 **Attention :** Ne montez pas le châssis dans des endroits où de la condensation peut se produire.

 **Avertissement :** protégez l'appareil de tout risque de ruissellement ou d'éclaboussure. Ne placez pas d'objets contenant des liquides, tels que des vases, sur l'appareil. Comme avec tout appareil électronique, veillez à ne pas renverser de liquides sur une partie quelconque de l'appareil. Les liquides peuvent provoquer des pannes et/ou un risque d'incendie.

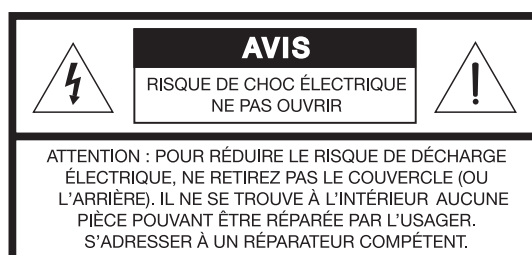

 Le symbole représentant un éclair avec une flèche à l'intérieur d'un triangle équilatéral est utilisé pour prévenir l'utilisateur de la présence d'une tension électrique dangereuse non isolée à l'intérieur de l'appareil. Cette tension est d'un niveau suffisamment élevé pour représenter un risque d'électrocution. Ne touchez pas les bornes de sortie lorsque l'amplificateur est allumé. Mettez l'amplificateur hors tension avant de réaliser toute connexion.

 Le symbole représentant un point d'exclamation à l'intérieur d'un triangle équilatéral, tel qu'il figure sur le système, signale à l'utilisateur la présence d'instructions importantes relatives au fonctionnement et à l'entretien de l'appareil dans cette notice d'installation.

 **Attention :** Cet appareil doit être raccordé à une prise secteur dotée d'une mise à la terre.

 **Attention :** Ne placez aucune source de flamme nue, comme une bougie allumée, sur ou près de l'appareil.

 **Attention :** Certaines pièces présentent un risque de suffocation. Ne pas laisser à la portée des enfants de moins de 3 ans.

**Remarque :** L'étiquette d'identification du produit est située au-dessous de l'appareil.

**Remarque :** Lorsque la fiche d'alimentation ou la prise multiple est utilisée comme dispositif de débranchement de l'appareil, elle doit rester facilement accessible.

**Remarque :** Ce produit doit être utilisé à l'intérieur. Il n'a pas été conçu ni testé pour une utilisation en extérieur, dans des véhicules ou sur des bateaux.

**Note :** When placing the amplifier on a flat surface, use the included feet to ensure proper ventilation. One amplifier can be stacked on top of another when feet are installed on both amplifiers. To install feet, place amplifier upside-down, insert the four feet into the four holes on the bottom of the chassis. To lock each foot into place, press a locking pin into each foot hole.

**Note :** Allow 1RU spacing above and below rack-mounted amplifiers to ensure sufficient spacing for ventilation. Additionally, the temperature of the rack should be controlled to ensure that amplifiers are not exposed to temperatures exceeding 40° C (104° F).

1. Veuillez lire ces instructions.
2. Conservez-les pour toute référence ultérieure.
3. Respectez tous les avertissements qui figurent sur le produit ou dans sa notice d'utilisation.
4. Suivez toutes les instructions.
5. N'utilisez pas cet appareil à proximité d'eau ou d'une source d'humidité.
6. Utilisez uniquement un chiffon sec pour le nettoyage.
7. Ne bloquez jamais les orifices d'aération. Suivez les instructions du fabricant pour l'installation. Pour garantir un fonctionnement fiable du produit et le protéger contre tout risque de surchauffe, installez-le à un emplacement et dans une position permettant d'assurer une ventilation correcte.
8. N'installez pas cet appareil à proximité d'une quelconque source de chaleur, telle qu'un radiateur, une arrivée d'air chaud, un four ou tout autre appareil (notamment des amplificateurs) produisant de la chaleur.
9. Veillez à profiter de la sécurité offerte par les fiches de type terre ou polarisées. Les fiches polarisées sont équipées de deux bornes de largeurs différentes. Les fiches de type terre sont équipées de deux bornes et d'un orifice pour la mise à la terre. Ces deux types de dispositifs ont pour but d'assurer votre sécurité. Si la prise fournie ne s'adapte pas à votre prise de courant, consultez un électricien pour qu'il remplace cette prise obsolète.
10. Protégez le cordon d'alimentation contre les risques de piétinement ou de pincement, notamment au niveau des fiches, des prises de courant et des branchements à l'appareil.
11. Utilisez uniquement les accessoires spécifiés par le fabricant.
12.  Utilisez uniquement le chariot, le support, le trépied, l'équerre ou la table spécifié(e) par le fabricant ou vendu(e) avec l'appareil. Si vous utilisez un chariot, faites attention à ne pas faire basculer l'ensemble chariot/appareil pour éviter de vous blesser en cas de chute.
13. Débranchez cet appareil pendant les orages ou en cas d'inutilisation prolongée, afin d'éviter de l'endommager.
14. Confiez toute réparation à du personnel qualifié. Une réparation est nécessaire lorsque l'appareil a été endommagé de quelque façon que ce soit (endommagement du cordon d'alimentation ou de la fiche électrique, renversement d'un liquide ou de tout objet sur l'appareil, exposition de l'appareil à la pluie ou à l'humidité, mauvais fonctionnement, chute de l'appareil, etc.). Ne tentez pas de réparer ce produit vous-même. L'ouverture ou la dépose d'un couvercle risque de vous exposer à des tensions électriques ou autres dangers. Veuillez contacter Bose pour connaître les coordonnées du centre de réparation agréé le plus proche.
15. Pour éviter tout risque d'incendie ou d'électrocution, ne surchargez pas les prises murales, les rallonges ou les prises multiples.
16. Ne laissez jamais de l'eau ou des objets pénétrer à l'intérieur du produit : des éléments sous tension pourraient être touchés, et un court-circuit risquerait de provoquer un incendie ou une électrocution.
17. Veillez à ne pas utiliser l'appareil à une température supérieure à 40 °C. Gardez à l'esprit le fait que la température à l'intérieur d'un rack fermé peut être très supérieure à la température ambiante.

**CE** Ce produit est conforme à toutes les directives de la Communauté Européenne qui s'y appliquent. L'attestation complète de conformité est disponible à l'adresse [www.Bose.com/compliance](http://www.Bose.com/compliance).

**Ce produit répond aux critères d'immunité des directives EN55103-2 pour les appareils de classe E2.**

Courant d'appel à la mise sous tension : 13.9 A (230V/50 Hz), 7.6 A (120V/60 Hz)

Courant d'appel après une interruption de 5 secondes de l'alimentation secteur : 13.9 A (230V/50 Hz), 7.5 A (120V/60 Hz)

**Informations sur les produits générateurs de bruit électrique (Notice de conformité FCC pour les USA)**

**Remarque :** ce matériel a fait l'objet de tests prouvant sa conformité aux limites imposées aux appareils numériques de classe A, conformément à la partie 15 des réglementations de la FCC. Ces limites sont conçues pour offrir une protection raisonnable contre les interférences nuisibles lorsque l'appareil est utilisé en environnement commercial. Cet appareil génère, utilise et est susceptible d'émettre de l'énergie à certaines fréquences radio. À ce titre, s'il n'est pas installé ou utilisé conformément aux instructions, il est susceptible de perturber les communications radio. L'utilisation de cet équipement dans une zone résidentielle risque de provoquer des interférences nuisibles, auquel cas l'utilisateur devra remédier au problème à ses propres frais.

**Ce produit est conforme aux spécifications de la réglementation ICES-003 pour la classe A du Canada.**

 **Questo prodotto deve essere installato unicamente da installatori professionisti.** Questo documento ha lo scopo di fornire agli installatori professionisti le istruzioni di base per l'installazione e la sicurezza degli amplificatori Bose® FreeSpace® negli impianti convenzionali a installazione fissa. Leggere attentamente il documento prima di procedere all'installazione.

 **Avvertenza:** Tutti i prodotti Bose devono essere utilizzati in conformità con gli standard locali, statali, federali e di settore. È responsabilità dell'installatore assicurare che l'installazione dell'amplificatore venga eseguita in conformità con le normative vigenti, compresi i regolamenti edilizi locali. Prima di installare il prodotto, chiedere informazioni all'autorità locale preposta.

 **Avvertenza:** Per ridurre il rischio di incendio o scarica elettrica, non esporre il prodotto alla pioggia o all'umidità.

 **Attenzione:** Non montare il telaio in posizioni dove potrebbe formarsi della condensa.

 **Avvertenza:** Non esporre l'apparecchio a gocce o schizzi e non porre oggetti colmi di liquidi, quali vasi, sopra o accanto all'apparecchio. Come per qualsiasi prodotto elettronico, è importante che all'interno delle parti del sistema non penetrino liquidi in quanto potrebbero causare guasti e/o rischio di incendio.



 Il simbolo del lampo con freccia racchiuso in un triangolo equilatero indica all'utilizzatore che all'interno dell'involucro è presente una tensione non isolata di entità tale da rappresentare un potenziale pericolo di scarica elettrica. Non toccare i terminali di uscita quando l'amplificatore è acceso. Disattivare prima tutti i collegamenti con l'amplificatore.

 Il simbolo del punto esclamativo racchiuso all'interno di un triangolo equilatero, che appare sul sistema, rimanda l'utente alla lettura di istruzioni d'uso e manutenzione importanti contenute in questa guida.

 **Attenzione:** Questo prodotto deve essere collegato a una presa di corrente alternata dotata di un impianto protettivo di messa a terra.

 **Attenzione:** Non collocare sorgenti di fiamme libere (ad esempio candele accese) sull'apparecchio o nelle vicinanze dello stesso.

 **Avvertenza:** Contiene pezzi di piccole dimensioni che possono rappresentare un pericolo di soffocamento. Non adatto per bambini di età inferiore ai 3 anni.

**Nota:** L'etichetta identificativa è situata sul fondo del prodotto.

**Nota:** La spina dell'alimentazione o dell'accoppiatore deve essere raggiungibile facilmente e rapidamente se è utilizzata come dispositivo di spegnimento.

**Nota:** Il prodotto è destinato all'uso in ambienti interni. Non è stato progettato né collaudato per l'uso in ambienti esterni, camper o imbarcazioni.

**Note:** When placing the amplifier on a flat surface, use the included feet to ensure proper ventilation. One amplifier can be stacked on top of another when feet are installed on both amplifiers. To install feet, place amplifier upside-down, insert the four feet into the four holes on the bottom of the chassis. To lock each foot into place, press a locking pin into each foot hole.

**Note:** Allow 1RU spacing above and below rack-mounted amplifiers to ensure sufficient spacing for ventilation. Additionally, the temperature of the rack should be controlled to ensure that amplifiers are not exposed to temperatures exceeding 40° C (104° F).

1. Leggere queste istruzioni.
2. Conservare queste istruzioni come riferimento per il futuro.
3. Osservare tutte le avvertenze riportate sul prodotto e nella relativa documentazione.
4. Seguire tutte le istruzioni.
5. Non utilizzare l'apparecchio in prossimità di acqua.
6. Utilizzare solo un panno asciutto per la pulizia.
7. Non ostruire le aperture di ventilazione. Installare il prodotto in conformità con le istruzioni fornite dal produttore. Per assicurare un funzionamento ottimale del prodotto e impedirne il surriscaldamento, collocarlo in una posizione e in un luogo tali da non impedire la corretta ventilazione.
8. Non installare i diffusori in prossimità di fonti di calore, quali termosifoni, radiatori, stufe o altri apparati (compresi gli amplificatori) che generano calore.
9. Non escludere l'obiettivo di sicurezza della spina polarizzata o con messa a terra. Una spina polarizzata è dotata di due poli, uno più largo dell'altro. Una spina con messa a terra è dotata di due poli e di un terzo terminale di massa. Il polo più largo e il terzo terminale sono presenti per sicurezza. Se la spina in dotazione non è adatta alla presa, rivolgersi a un elettricista per la sostituzione della presa obsoleta.
10. Fare in modo che il cavo di alimentazione non venga calpestato o schiacciato, soprattutto in corrispondenza di spine, prese e nel punto di uscita dall'apparato.
11. Utilizzare solo sistemi di aggancio/accessori specificati dal produttore.
12.  Utilizzare solo carrelli, supporti, treppiedi, staffe o tavoli specificati dal produttore o venduti insieme all'apparato. Quando si utilizza un carrello, prestare attenzione durante lo spostamento dell'insieme carrello/apparato per evitare di rovesciarlo causando danni.
13. Scollegare l'apparato durante i temporali o quando rimane inutilizzato a lungo per evitare di danneggiare il prodotto.
14. Affidarsi a personale qualificato per tutti gli interventi di assistenza. L'assistenza è necessaria in caso di danni all'apparecchio: ad esempio quando il cavo di alimentazione o la spina sono danneggiati, se sono stati versati liquidi o sono caduti oggetti nell'apparato, se quest'ultimo è stato esposto a pioggia o umidità, non funziona correttamente o è caduto. Non tentare di ripararlo autonomamente. L'apertura o la rimozione di coperchi può comportare l'esposizione a tensioni pericolose o altri pericoli. Chiamare Bose per ottenere il recapito del centro assistenza autorizzato di zona.
15. Per prevenire il rischio di incendi o scosse elettriche, evitare di sovraccaricare le prese elettriche, le prolunghie o le prese multiservizio.
16. Non lasciare penetrare nel prodotto oggetti o liquidi che potrebbero venire a contatto con punti in cui sono presenti tensioni pericolose o provocare cortocircuiti o dare adito a incendi o scosse elettriche.
17. Non lasciare che l'unità superi la temperatura operativa massima di 40° C. In caso di installazione all'interno di un rack chiuso, tenere presente che la temperatura dell'unità potrebbe superare quella dell'ambiente circostante.

**CE** Questo prodotto è conforme a tutte le direttive EU prescritte dalla legge. La dichiarazione di conformità completa è disponibile all'indirizzo [www.Bose.com/compliance](http://www.Bose.com/compliance).

**Questo prodotto è conforme ai requisiti di immunità previsti dalla direttiva EN55103-2 per la classe E2.**





Corrente di spunto iniziale all'accensione: 13.9 Amp (230V/50 Hz), 7.6 Amp (120V/60 Hz)

Corrente di spunto dopo 5 secondi di interruzione dell'alimentazione CA: 13.9 Amp (230V/50 Hz), 7.5 Amp (120V/60 Hz)





**Informazioni sui prodotti che generano interferenze elettriche (avviso di conformità FCC per gli Stati Uniti)**

**Nota** Questa apparecchiatura è stata sottoposta a collaudo ed è risultata conforme ai limiti relativi ai dispositivi digitali di Classe A previsti dalla parte 15 delle norme FCC. Tali limiti sono stati fissati allo scopo di assicurare un'adeguata protezione dalle interferenze dannose quando l'apparecchiatura è utilizzata in un'installazione commerciale. Questa apparecchiatura genera, utilizza e può irradiare energia a radiofrequenza e, se non installata e utilizzata in conformità con il manuale di istruzioni, può interferire negativamente con le comunicazioni radiofoniche. L'utilizzo di questa apparecchiatura in un'area residenziale può provocare interferenze dannose, nel qual caso l'utente dovrà adottare misure correttive a proprie spese.

**Questo prodotto è conforme alle specifiche canadesi ICES-003 per i prodotti di Classe A.**

-  **Dit product is uitsluitend bestemd voor installatie door professionele installateurs!** Dit document is bedoeld om basisrichtlijnen met betrekking tot de installatie en veiligheid te bieden voor professionele installateurs voor Bose® FreeSpace®-versterkers in standaardssystemen voor vaste installatie. Lees dit document door voordat u begint met de installatie.
-  **Waarschuwing:** Alle Bose-producten moeten worden gebruikt volgens de plaatselijke en landelijke voorschriften en industriënormen. Het is de verantwoordelijkheid van de installateur om ervoor te zorgen dat de installatie van de versterker wordt uitgevoerd volgens alle van toepassing zijnde voorschriften, inclusief plaatselijke bouwvoorschriften. Neem contact op met de juiste plaatselijke overheidsinstanties voordat u dit product installeert.
-  **Waarschuwing:** Om het risico van brand of elektrische schokken te verlagen, mag dit product niet worden blootgesteld aan regen of vocht.
-  **Opgelet:** Monteer het chassis niet op plaatsen waar condensatie kan optreden.
-  **Waarschuwing:** Dit apparaat mag niet worden blootgesteld aan druipende of spattende vloeistoffen, en voorwerpen gevuld met vloeistoffen, zoals vazen, mogen niet op of bij het apparaat worden geplaatst. Evenals bij andere elektronische producten dient u op te letten dat er geen vloeistof op enig deel van het systeem terecht komt. Vloeistoffen kunnen leiden tot storing en/of brandgevaar.



-  Het symbool met bliksemschicht en pijl in een gelijkzijdige driehoek is bedoeld om de gebruiker te waarschuwen voor de aanwezigheid van gevaarlijke niet-geïsoleerde spanning in het systeem die hoog genoeg kan zijn om een risico van elektrische schokken te vormen. Raak de uitgangsklemmen niet aan wanneer de versterker aanstaat. Sluit alle aansluitingen op de versterker af.
-  Het uitroepteken in de driehoek dat is afgebeeld op het systeem maakt de gebruiker attent op belangrijke bedienings- en onderhoudsinstructies in deze installatiehandleiding.
-  **Opgelet:** Dit product moet worden aangesloten op een geaard stopcontact.
-  **Opgelet:** Plaats geen open vlammen, zoals brandende kaarsen, op of bij het apparaat.
-  **Waarschuwing:** Bevat kleine onderdelen die een verstikkingsgevaar kunnen vormen. Niet geschikt voor kinderen jonger dan 3 jaar.

**Opmerking:** Het productlabel bevindt zich aan de onderkant van het product.

**Opmerking:** Wanneer de netstekker of connector als stroomonderbreker wordt gebruikt, dient een dergelijke stroomonderbreker gemakkelijk te bedienen te zijn.

**Opmerking:** Het product is alleen bestemd voor gebruik binnenshuis. Het is niet ontworpen of getest voor gebruik buitenshuis, in recreatievoertuigen of op boten.

**Note:** When placing the amplifier on a flat surface, use the included feet to ensure proper ventilation. One amplifier can be stacked on top of another when feet are installed on both amplifiers. To install feet, place amplifier upside-down, insert the four feet into the four holes on the bottom of the chassis. To lock each foot into place, press a locking pin into each foot hole.

**Note:** Allow 1RU spacing above and below rack-mounted amplifiers to ensure sufficient spacing for ventilation. Additionally, the temperature of the rack should be controlled to ensure that amplifiers are not exposed to temperatures exceeding 40° C (104° F).



1. Lees deze instructies door.
2. Bewaar deze instructies voor toekomstig gebruik.
3. Neem alle waarschuwingen in acht, zowel waarschuwingen op het product als in de documentatie van het product.
4. Volg alle instructies.
5. Gebruik dit apparaat niet in de buurt van water.
6. Reinig het apparaat alleen met een droge doek.
7. De ventilatieopeningen niet blokkeren. Installeren volgens de instructies van de fabrikant. Om een betrouwbare werking van het product te waarborgen en dit te beschermen tegen oververhitting, dient u het in een positie en op een plaats te zetten waar de ventilatie niet wordt belemmerd.
8. Niet installeren in de buurt van warmtebronnen, zoals radiatoren, verwarmingsroosters, kachels of andere apparaten (waaronder versterkers) die warmte produceren.
9. Schakel de veiligheidsfunctie van de gepolariseerde of aardingsstekker niet uit. Een gepolariseerde stekker heeft twee contactpennen waarbij de ene breder is dan de andere. Een geaarde stekker heeft twee contactpennen en een derde voor de aarding. De brede contactpen of derde contactpen dient voor uw veiligheid. Als de stekker niet in het stopcontact past, dient u contact op te nemen met een elektricien om het verouderde stopcontact te vervangen.
10. Zorg dat er niet op het netsnoer wordt gestaan of gelopen en dat het niet wordt afgeknelde, met name bij de stekkers en stopcontacten en het punt waar deze uit het apparaat komen.
11. Gebruik uitsluitend randapparatuur/accessoires die worden gespecificeerd door de fabrikant.
12.  Uitsluitend gebruiken in combinatie met het door de fabrikant voorgeschreven verrijdbare plateau, statief, drievoetbeugel of tafel die bij het apparaat wordt verkocht. Als u een verrijdbaar plateau gebruikt, moet u het plateau en het apparaat voorzichtig verplaatsen om letsel als gevolg van omvallen te voorkomen.
13. Verwijder de stekker van dit apparaat uit het stopcontact tijdens onweer of wanneer het lange tijd niet wordt gebruikt, om schade aan het product te voorkomen.
14. Laat alle onderhoud over aan bevoegd onderhoudspersoneel. Reparatie is vereist als het apparaat beschadigd is, zoals bij beschadiging van het netsnoer of de stekker; als er vloeistof in het apparaat terechtgekomen is of voorwerpen op het apparaat zijn gevallen; als het apparaat is blootgesteld aan regen of vocht, niet normaal werkt of is gevallen. Probeer dit product niet zelf te repareren. Door afdekkingen te openen of te verwijderen kunt u worden blootgesteld aan gevaarlijke spanningen of andere gevaren. Bel Bose voor een erkend servicecentrum bij u in de buurt.
15. Om het risico van brand of elektrische schokken te voorkomen, dient u overbelasting van wandcontactdozen, verlengsnoeren of stekkerdozen te voorkomen.
16. Zorg dat er geen voorwerpen of vloeistoffen in het product terechtkomen. Deze kunnen in contact komen met punten met gevaarlijke spanningen of kortslui of kortsluiting veroorzaken, hetgeen kan leiden tot brand of elektrische schokken.
17. Zorg dat het apparaat de maximale bedrijfstemperatuur van 40°C niet overschrijdt. Houd er rekening mee dat bij een afgesloten rek de temperatuur kan stijgen tot boven de omgevingstemperatuur.

**CE** Dit product voldoet aan alle vereisten van de EU-richtlijnen, zoals wettelijk vereist. De volledige conformiteitsverklaring kunt u vinden op [www.Bose.com/compliance](http://www.Bose.com/compliance).

**Dit product voldoet aan de immuniteitseisen van de richtlijn EN55103-2 klasse E2.**

Inschakelstroomstoot: 13.9 A (230V/50 Hz), 7.6 A (120V/60 Hz)

Inschakelstroom na 5 seconden stroomuitval: 13.9 A (230V/50 Hz), 7.5 A (120V/60 Hz)

**Informatie over producten die elektrische ruis genereren (FCC Compliance Notice voor de VS)**

**Opmerking:** Dit apparaat is getest waarbij is vastgesteld dat het voldoet aan de limieten voor een digitaal apparaat van klasse A, volgens deel 15 van de FCC-voorschriften. Deze limieten zijn bedoeld om redelijke bescherming te bieden tegen schadelijke storing bij installatie in een handelsomgeving. Dit apparaat genereert en gebruikt radiofrequente energie en kan deze uitstralen en het kan, als het niet geïnstalleerd en gebruikt wordt volgens de instructies, schadelijke storing veroorzaken aan radiocommunicatie. Gebruik van dit apparaat in een woonwijk kan schadelijke storing veroorzaken. In dit geval is de gebruiker verplicht op eigen kosten de storing te verhelpen.

**Dit product voldoet aan de specificaties van de Canadese ICES-003 klasse A.**

 **Denna produkt ska endast installeras av välutbildade installatörer.** Detta dokument är avsett för professionella installatörer som behöver enkla riktlinjer för installation och säkerhet för Bose® FreeSpace®-förstärkare i vanliga fasta systeminstallationer. Läs igenom dokumentet innan du påbörjar installationen.

 **Varning!** Alla Bose-produkter måste användas enligt lokala lagar och bestämmelser. Det är installatörens ansvar att förstärkarinstallationen utförs enligt gällande lagar och regler, inklusive lokala bestämmelser och förordningar i huset. Kontakta berörd lokal myndighet innan du installerar produkten.

 **Varning!** Minska risken för brand eller elektriska stötar genom att inte utsätta produkten för regn eller fukt.

 **Varning!** Montera inte chassit på platser där kondens kan förekomma.

 **Varning!** Utsätt inte produkten för vätska och placera inga föremål som exempelvis vaser fyllda med vätska på systemet eller i dess närhet. Precis som med andra elektroniska produkter bör du vara försiktig så att du inte spillar vätska i någon del av systemet. Vätskor kan orsaka fel och/eller brand.

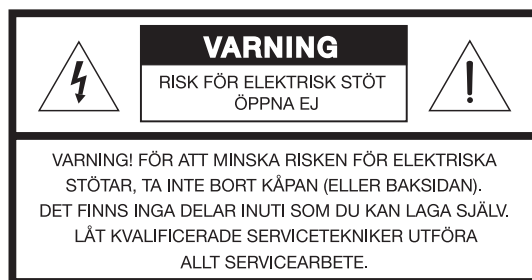

 Symbolen med en pilförsedd blixtnuti en liksidig triangel är avsedd att varna användaren för oisolerad, farlig spänning inuti produkten. Denna spänning kan vara kraftig nog att ge elektriska stötar. Rör inte kontaktarna medan förstärkaren är påslagen. Se till att alla anslutningar är frånkopplade.

 Utropstecknet i en triangel, som finns på systemet, vill uppmärksamma användaren på att det finns viktiga användnings- och underhållsanvisningar i den här installationsanvisningen.

 **Varning!** Den här produkten ska anslutas till ett skyddsjordat eluttag.

 **Varning!** Tända ljus eller andra föremål med öppna lågor får inte placeras på eller i närheten av produkten.

 **Varning!** Produkten innehåller små delar som kan orsaka kvävning. Inte lämplig för barn under 3 år.

**Obs!** På produktens undersida finns en etikett.

**Obs!** Om produkten kopplas bort från strömförsörjningen med nätkabelns eller produktens kontakt ska det vara lätt att komma åt och använda denna kontakt.

**Obs!** Produkten får bara användas inomhus. Den är varken utformad eller testad för användning utomhus, i nöjesfordon eller marina miljöer.

**Note:** When placing the amplifier on a flat surface, use the included feet to ensure proper ventilation. One amplifier can be stacked on top of another when feet are installed on both amplifiers. To install feet, place amplifier upside-down, insert the four feet into the four holes on the bottom of the chassis. To lock each foot into place, press a locking pin into each foot hole.

**Note:** Allow 1RU spacing above and below rack-mounted amplifiers to ensure sufficient spacing for ventilation. Additionally, the temperature of the rack should be controlled to ensure that amplifiers are not exposed to temperatures exceeding 40° C (104° F).

1. Läs de här anvisningarna.
2. Spara anvisningarna för framtida referens.
3. Var uppmärksam på alla varningar, både på produkten och i all dokumentation.
4. Följ alla anvisningar.
5. Använd inte produkten i närheten av vatten.
6. Rengör endast med en torr trasa.
7. Blockera inte ventilationsöppningarna. Installera produkten i enlighet med tillverkarens anvisningar. För att produkten ska fungera tillförlitligt och skyddas från överhettning ska den placeras i ett sådant läge och på en sådan plats att tillräcklig luftväxling kan ske.
8. Installera inte produkten nära en värmekälla (som t.ex. radiator, värmespjäll och spisar) eller annan apparat (inklusive förstärkare) som avger värme.
9. Åsidosätt inte säkerhetsfunktionen i en polariserad eller jordad kontakt. En polariserad kontakt har två flata stift, det ena bredare än det andra. En jordad kontakt har två stift och ett tredje jordat stift. Det breda stiftet och jordstiftet finns där för att öka säkerheten. Om den medföljande kontakten inte passar i ditt eluttag ska du be en elektriker att byta ut det föråldrade uttaget.
10. Skydda elkabeln så att ingen trampar på den och så att den inte kommer i kläm. Detta är särskilt viktigt vid kontaktorna, tillbehörsuttagen och den plats där elsladden kommer ut ur produkten.
11. Använd bara den utrustning/de tillbehör som rekommenderas av tillverkaren.
12.  Använd endast produkten tillsammans med vagnen, stället, stativet, fästet eller bordet som rekommenderas av tillverkaren eller säljs tillsammans med produkten. Om en vagn används ska du vara försiktig när du flyttar vagnen med produkten på så att den inte välter och orsakar skada.
13. För att undvika skador på produkten ska du koppla bort produkten från eluttaget när åskan går eller om produkten inte ska användas under en längre period.
14. Låt utbildad servicepersonal utföra all service. Underhåll krävs när produkten skadats, t.ex. skada på kabel eller kontakt, vätska har spillts i produkten eller främmande föremål har hamnat i den; produkten har utsatts för regn eller fukt; produkten fungerar inte felfritt eller har tappats. Försök inte åtgärda felet själv. Om du öppnar eller tar bort några skydd riskerar du att utsättas för farlig elektrisk spänning eller andra faror. Ring till Bose så hjälper vi dig att hitta ett auktoriserat servicecenter nära dig.
15. För att förhindra risken för brand eller elektriska stötar ska du undvika att överbelasta eluttag, förlängningssladdar och inbyggda tillbehörsuttag.
16. Låt inga föremål eller vätskor komma in i produkten – de kan komma i kontakt med ledande spänningar och/eller kortsluta delar, vilket kan medföra brand och/eller elektriska stötar.
17. Låt inte temperaturen i enheten överstiga den maximala drifttemperaturen som är 40° C. Tänk på att temperaturen i ett instängt rackskåp kan bli högre än den i rummet.

 Denna produkt uppfyller alla EU-direktiv som krävs enligt lag. En komplett försäkran om överensstämmelse finns på [www.Bose.com/compliance](http://www.Bose.com/compliance).

**Den här produkten uppfyller immunitetskraven enligt E2-klassen i direktivet EN55103-2.**

Sätt initialt in inkommande strömstyrka: 13.9 Amp (230V/50 Hz), 7.6 Amp (120V/60 Hz)

Inkommande strömstyrka efter fem sekunders strömavbrott: 13.9 Amp (230V/50 Hz), 7.5 Amp (120V/60 Hz)

**Information om produkter som genererar elektriskt brus (Meddelande angående FCC-överensstämmelse för USA)**

**Obs!** Den här utrustningen har testats och befunnits överensstämma med gränsvärdena för digitala enheter av klass A, i enlighet med del 15 i FCC:s bestämmelser. Gränsvärdena är avsedda att ge rimligt skydd mot skadliga störningar när utrustningen används i en kommersiell miljö. Den här utrustningen genererar, använder och kan avge radiofrekvensenergi, och om utrustningen inte installeras och används i enlighet med anvisningarna kan den orsaka skadliga störningar i samband med radiokommunikation. Användning av denna utrustning i bostäder kan orsaka skadliga störningar som användaren själv måste åtgärda och bekosta.

**Den här produkten överensstämmer med specifikationerna för klass A i kanadensiska ICES-003.**

## Introduction

This guide describes the installation and operating procedures for the following:

- FreeSpace® IZA 190-HZ integrated zone amplifier
- FreeSpace IZA 250-LZ integrated zone amplifier
- FreeSpace ZA 190-HZ zone amplifier
- FreeSpace ZA 250-LZ zone amplifier

## FreeSpace® IZA 190-HZ/IZA 250-LZ integrated zone amplifier

### Contents

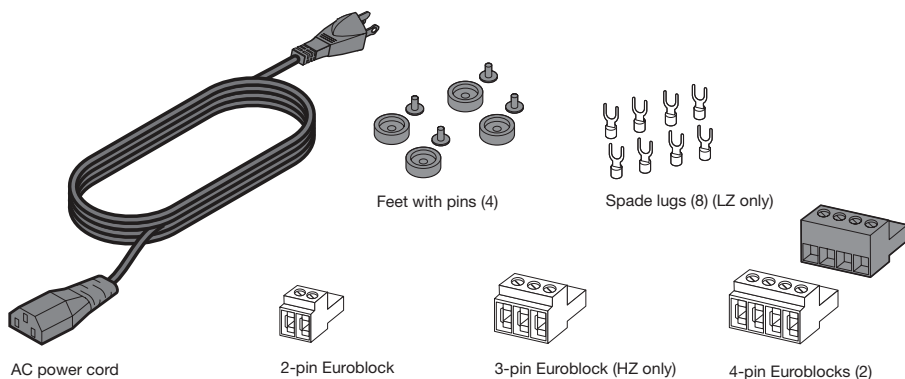

- (1) Power cord
- (4) Feet with pins
- (1) 4-pin Euroblock for PAGE input
- (1) 4-pin Euroblock for REMOTE connections
- (1) 2-pin Euroblock for MUTE connection
- (8) Spade lugs for OUTPUT connections (LZ only)
- (1) 3-pin Euroblock for OUTPUT connection (HZ only)

### Front-panel

**Note:** Front-panel controls and indicators are identical on the FreeSpace IZA 190-HZ amplifier.

FreeSpace IZA 250-LZ

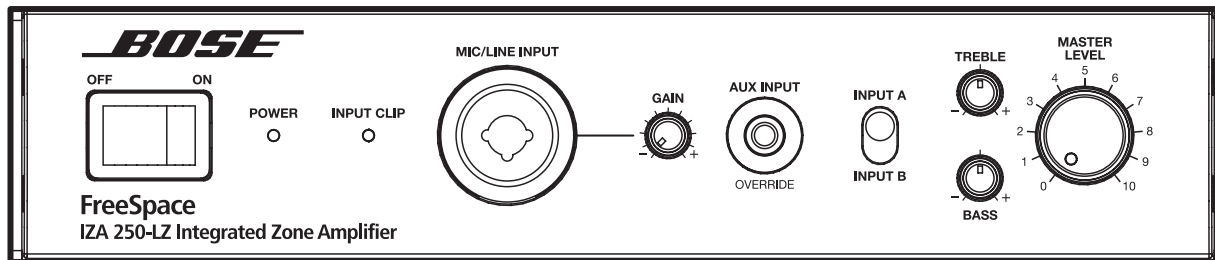

## Rear-panel

FreeSpace® IZA 190-HZ

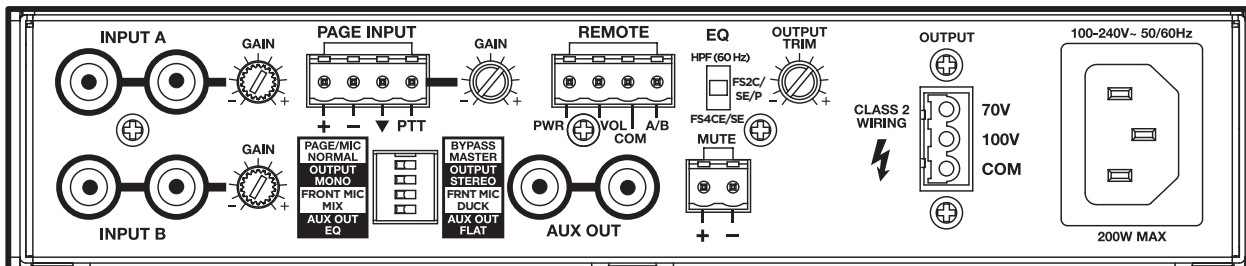

FreeSpace IZA 250-LZ

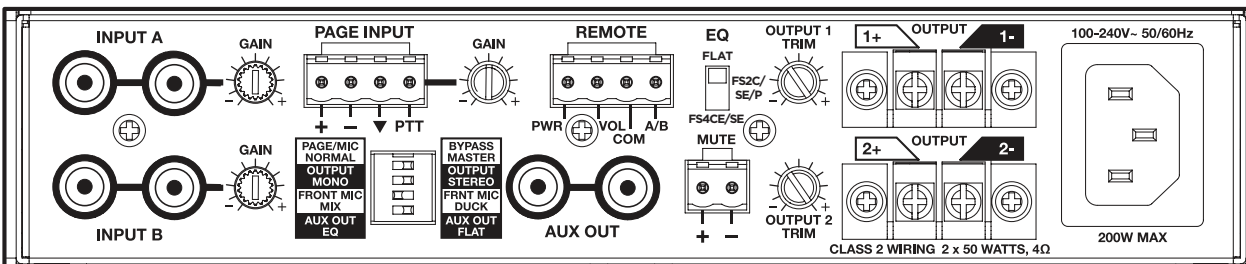

## Loudspeaker connections

Use 22 AWG (0.3 mm<sup>2</sup>) to 14 AWG (2.0 mm<sup>2</sup>) size wire only.

### Making loudspeaker connections (IZA 190-HZ)

**Note:** Loudspeaker connections are the same for the ZA 190-HZ amplifier.

Wire the 3-pin Euroblock:

Use pins 1 (70V) and 3 (COM) for 70V operation.

Use pins 2 (100V) and 3 (COM) for 100V operation

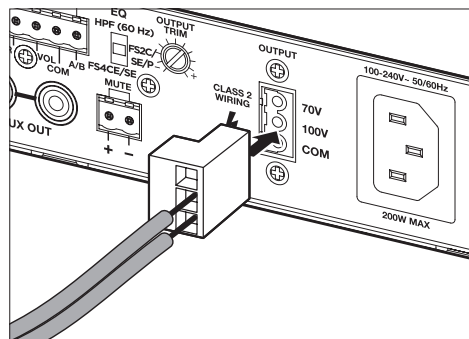
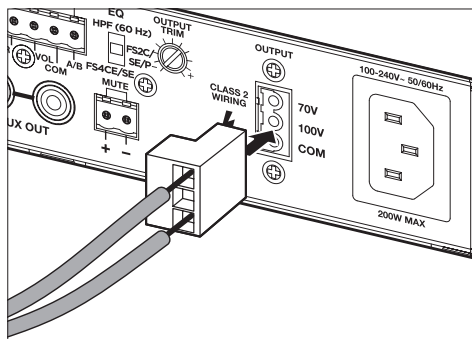

### Making loudspeaker connections (IZA 250-LZ)

**Note:** Loudspeaker connections are the same for the ZA 250-LZ amplifier.

1. Attach included crimp-on spade lug connectors to loudspeaker wiring. Blue spade lug connectors are compatible with 16-14 AWG wire. Red spade lug connectors are compatible with 22-16 AWG wire.

**Note:** You may need to bend the spade lugs to fit.

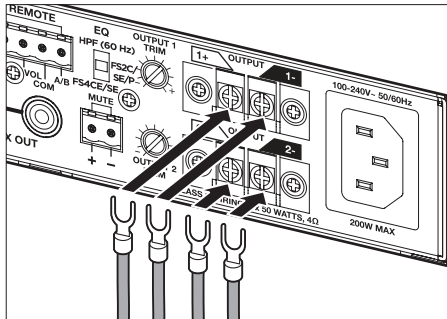

2. Make a single loudspeaker connection or connect two loudspeakers in parallel. When connecting the loudspeakers in parallel:
  - i. Connect the wires from the amplifier to the matching positive (+) and negative (-) terminals on the first loudspeaker.
  - ii. Connect the positive (+) and negative (-) terminals of the first loudspeaker to the positive (+) and negative (-) terminals of the second loudspeaker.

**Caution:** Do not connect more than two loudspeakers together in this manner. Doing so could damage the amplifier.

Single 4-8 ohm loudspeaker

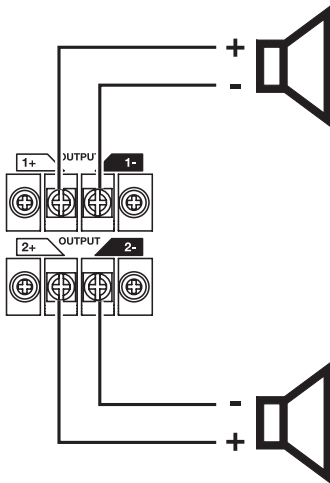

Two 8 ohm loudspeakers in parallel

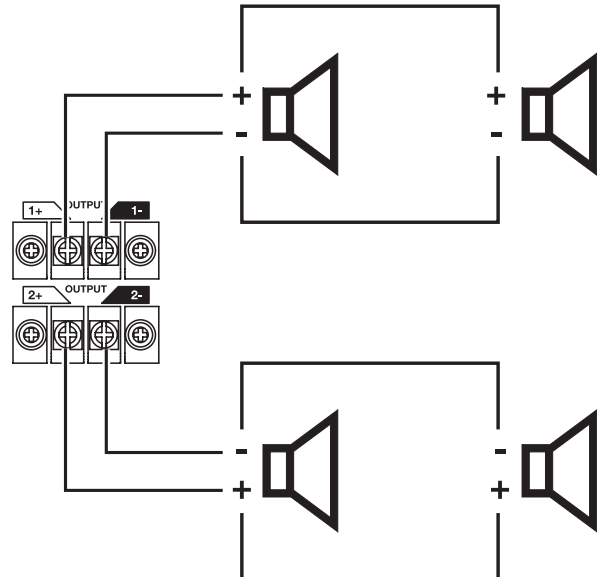

## Input connections

### RCA input connections

Insert the RCA plugs into the INPUT A or INPUT B connectors.

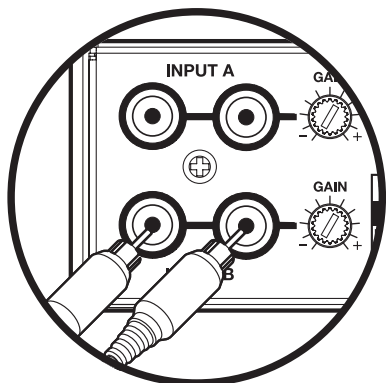

### Page input connections

The PAGE INPUT is a mic/line input with a trigger contact closure. This input signal is routed to all outputs (including AUX OUT) when the trigger is detected. This is designed for push-to-talk paging microphones and telephone paging systems. See the diagrams below for input wiring configurations. Use the included 4-pin Euroblock.

Source connector

PAGE INPUT

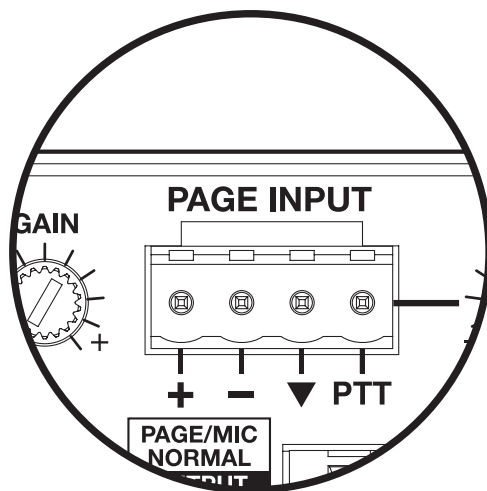
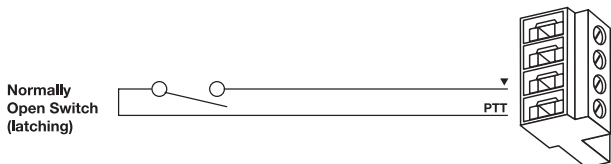
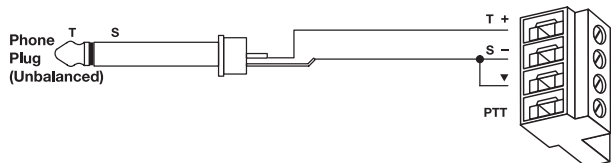
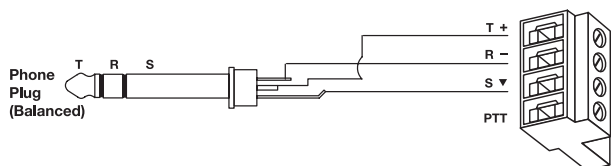
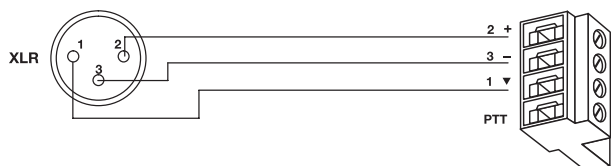
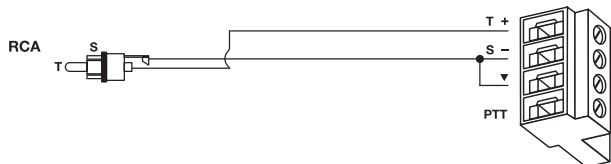

### Mic/Line input connections (Front-panel)

The MIC/LINE INPUT connector is designed for use with handheld dynamic microphones and XLR, TRS, or TS 1/4" microphone cables. Line-level sources also can be used with this input. See the diagrams below for input wiring configurations.

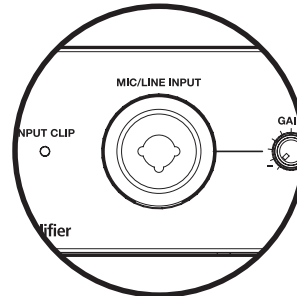
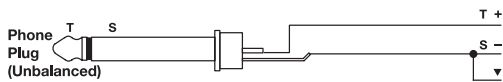
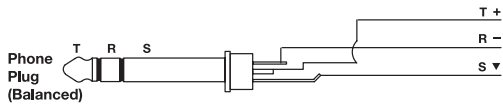
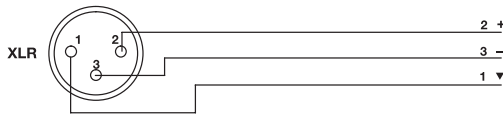

### Aux input (Front-panel)

The front panel auxiliary stereo line input connector is designed for connecting portable audio devices like MP3 players and laptops. When a 1/8" (3.5 mm) TRS input jack is connected to the AUX INPUT, the selected INPUT A/B is automatically overridden, even if the audio source connected to AUX INPUT is not playing.

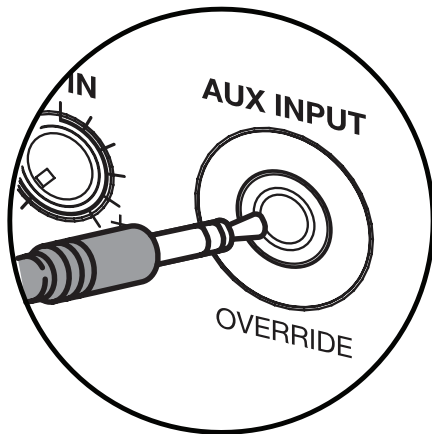



## Remote Control connections

### Remote volume and source selection control

The amplifier is designed to work with the Volume Control with A/B Select User Interface (PC 041967) accessory. The REMOTE connector on the rear panel of the amplifier is labeled to match the connector on the user interface. Use the included 4-pin Euroblock.

Volume Control with A/B Select User Interface

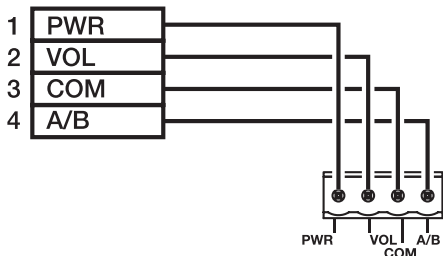

See the Bose® Volume Control with A/B Select User Interface install guide for more details.

The amplifier also can be controlled with a linear taper 10k ohm potentiometer (full CCW=0 ohm, full CW=10k ohm) and SPDT switch.

Volume Control with A/B Select

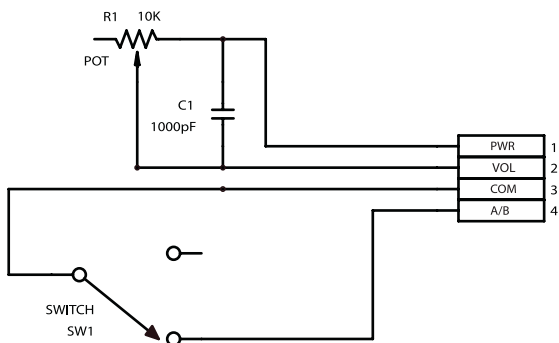

**Note:** The Bose Volume Control User Interface (PC 041966), not shown here, is not fully functional with the IZA 190-HZ and IZA 250-LZ amplifiers.

### Mute with standard contact closure

The amplifier is designed to mute all outputs (including AUX OUT) when a trigger is detected via the MUTE connector. This is triggered from a standard contact closure. Use the included 2-pin Euroblock.

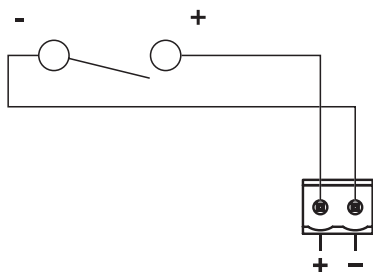

### AC power connection

Once all the input and output connections have been made on the rear panel, connect the amplifier to AC power with included power cord.

## Setup – Rear-panel controls

## FreeSpace IZA 190-HZ

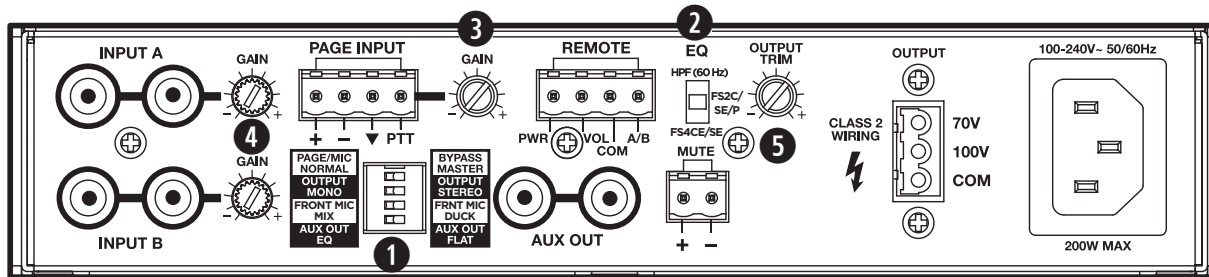

## FreeSpace IZA 250-LZ

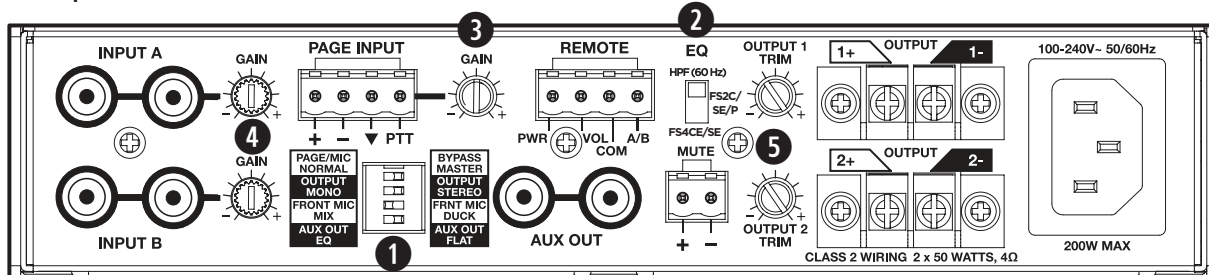

### 1 Amplifier mode DIP switches

#### • PAGE/MIC NORMAL – BYPASS MASTER

Determines if page input source will follow the master level output or can be set at a fixed output level to ensure announcements are heard. When set to BYPASS MASTER use the respective input gain controls to adjust the volume level of each microphone.

#### • OUTPUT MONO – OUTPUT STEREO

Determines if stereo input sources will be output in mono or stereo via loudspeaker connectors and AUX OUT RCA connectors. Using this switch in a mono position will help provide sufficient gain for single-input devices. Mono switch position will also sum stereo inputs for loudspeaker applications where stereo is not desired.

**Note:** On the IZA 250-LZ amplifier, OUTPUT 1 is the left channel and OUTPUT 2 is the right channel when set to OUTPUT STEREO. On the IZA 190-HZ, the left channel is routed to the loudspeaker output when set to OUTPUT STEREO.

#### • FRONT MIC MIX – FRONT MIC DUCK

Determines if front-panel microphone input will be mixed in with music source or if the music output level will be automatically lowered (“ducked”) when someone speaks into microphone.

#### • AUX OUT EQ – AUX OUT FLAT

Determines if AUX OUT will have selected loudspeaker EQ preset applied to it or not. Allows for optimization of FreeSpace FS2C/SE/P and FS4CE/SE loudspeakers when used with additional zone amplifiers.

### 2 Loudspeaker EQ preset switch

Provides loudspeaker equalization presets designed to optimize the performance of Bose FreeSpace FS2C/SE and FS4C/SE loudspeakers. A high-pass filter (HPF) setting is also available for use with any passive loudspeakers. The high-pass filter is set at 60 Hz for the IZA 190-HZ and at 40 Hz for the IZA 250-LZ.

The selected EQ preset (190-HZ: HPF (60 Hz), FS2C/SE/P, FS4CE/SE; 250-LZ: FLAT, FS2C/SE/P, FS4CE/SE) can be sent to an additional zone amplifier via AUX OUT if “AUX OUT EQ” is selected with the corresponding mode DIP switch.

### 3 Page input GAIN control

Allows for fine-tuning page input levels. If the front-panel INPUT CLIP indicator is red, reduce the input gain. The adjustment range is 0 dB to +50 dB.

### 4 Line input GAIN control

Allows for fine-tuning of INPUT A/B levels. If the front-panel INPUT CLIP indicator is red, reduce the input gain. The adjustment range is –20 dB to +20 dB.

### 5 Output TRIM control

Allows for attenuating individual loudspeaker outputs relative to the Master Level. The adjustment range is –20 dB to 0 dB. This feature is helpful when one output is powering loudspeakers that need to be set at a lower volume level than loudspeakers on other outputs – including the outputs of an additional zone amplifier.

## Operation – Front-panel controls and indicators

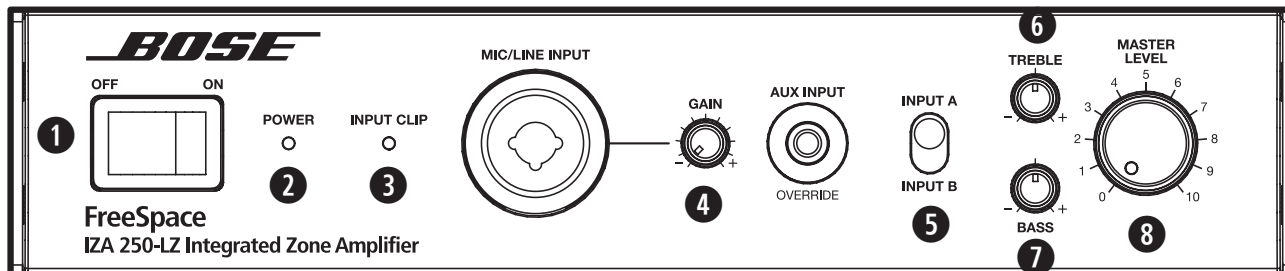

**Note:** Front-panel controls and indicators are identical on the FreeSpace® IZA 190-HZ amplifier.

- 1 OFF/ON switch**  
Turns amplifier on or off.
- 2 POWER indicator**  
Illuminates blue when amplifier is on.
- 3 INPUT CLIP indicator**  
Illuminates red whenever input source approaches the threshold value of -3dBFS. If the indicator illuminates frequently, reduce input signal level.
- 4 MIC/LINE INPUT GAIN control**  
Allows for fine-tuning of the MIC/LINE input level. If the INPUT CLIP indicator is red, reduce the input gain. The adjustment range is 0 dB to +50 dB.
- 5 INPUT A/B selector switch**  
Allows you to choose between rear line inputs A and B from the front panel of the amplifier.  
Rear line inputs A and B can also be selected remotely with the use of optional Bose Volume Control with A/B Select User Interface accessory.  
**Note:** When the Bose Volume Control with A/B Select User Interface is connected, the source select and the MASTER LEVEL control will be overridden by the controls on the remote user interface.

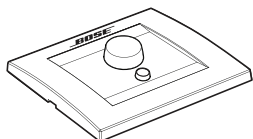

- 6 TREBLE control**  
Allows adjustment of the output tone. Provides +/-6 dB of adjustment at 7 kHz.
- 7 BASS control**  
Allows adjustment of the output tone. Provides +/-6 dB of adjustment at 100 Hz.
- 8 MASTER LEVEL control**  
Controls the overall system volume for both the loudspeakers and the variable AUX OUT.  
The Master Level can also be controlled remotely with the use of the optional Volume Control with A/B Select User Interface accessory.

# FreeSpace® ZA 190-HZ/250-LZ zone amplifier

## Contents

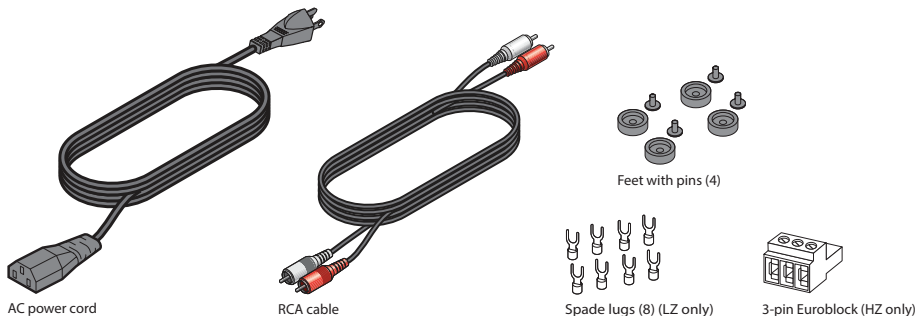

- (1) Power cord
- (1) RCA stereo cable
- (4) Feet with pins
- (8) Spade lugs (LZ only)
- (1) 3-pin Euroblock (HZ only)

## Front-panel controls and indicators

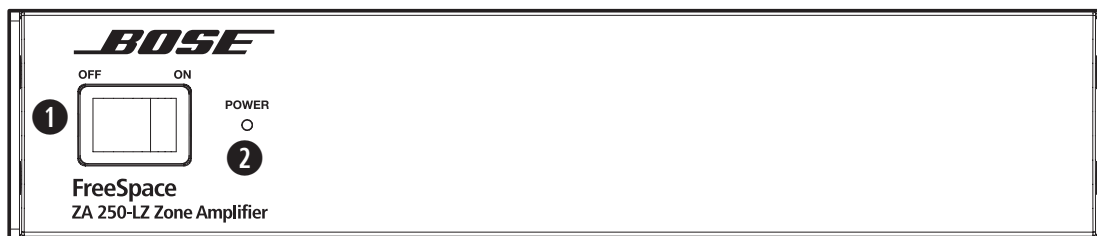

**Note:** Front-panel controls and indicators are identical on the FreeSpace® ZA 190-HZ amplifier.

- ❶ **OFF/ON switch**  
Turns amplifier on or off.
- ❷ **POWER indicator**  
Illuminates blue when amplifier is on.

## Rear-panel controls

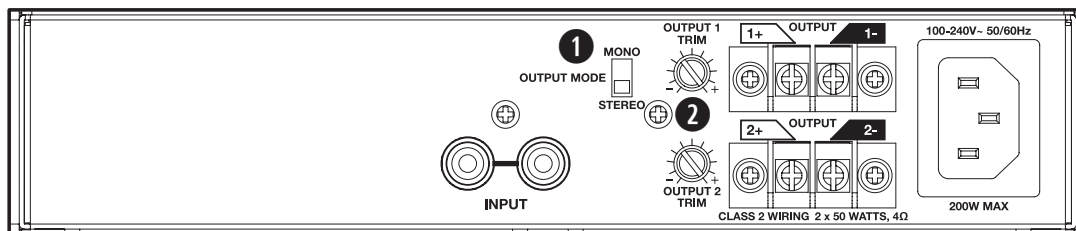

- ❶ **OUTPUT MODE switch (ZA 250-LZ only)**  
Allows stereo input sources to be output in mono or stereo.  
**Note:** The ZA 190-HZ is designed to sum both inputs channels to mono.
- ❷ **Output TRIM control**  
Allows for attenuating individual loudspeaker outputs relative to the Master Level of the connected IZA 190-HZ/250-LZ amplifier. The adjustment range is -20 dB to 0 dB. This feature is helpful when one output is powering loudspeakers that need to be set at a lower volume level than loudspeakers on other outputs – including the outputs of an integrated zone amplifier.

## Expanding an IZA system with a ZA amplifier

The Bose® FreeSpace® ZA 190-HZ/250-LZ zone amplifier makes system expansion easy. When a system design requires more loudspeakers than the FreeSpace IZA 190-HZ/250-LZ integrated zone amplifier can support, the FreeSpace ZA 190-HZ/250-LZ zone amplifier is available to provide additional output channels.

### System operation

The IZA 190-HZ/250-LZ and ZA 190-HZ/250-LZ amplifiers will function together as one system – sharing the same music and paging sources. The IZA 190-HZ/250-LZ amplifier functions as the “master” of the ZA 190-HZ/250-LZ amplifier – determining which audio sources will be heard and controlling the overall Master Level volume.

### Input connections

#### Connecting the IZA 190-HZ/250-LZ amplifier to the ZA 190-HZ/250-LZ amplifier

Connect the AUX OUT of the IZA 190-HZ/250-LZ amplifier to the INPUT of the ZA 190-HZ/250-LZ amplifier with the included RCA cable.

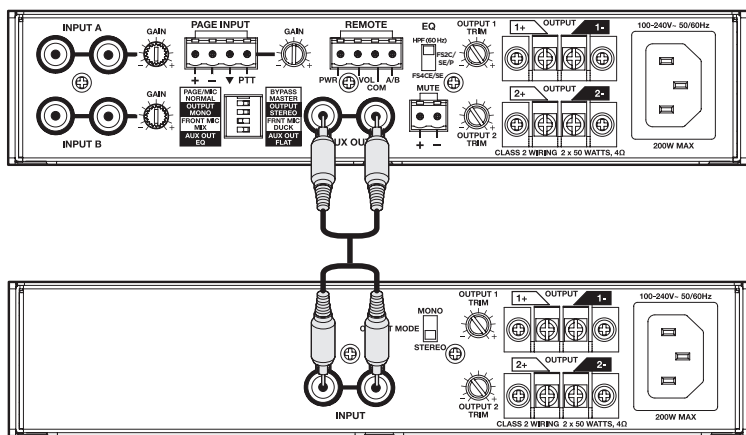

**Note:** It is recommended that when amplifiers are connected together, that both amplifier AC power cords are plugged into the same AC outlet.

#### Connecting the zone amplifier with other products

The zone amplifier can also be used as a standalone power amplifier with a front-end signal processor – including the Bose FreeSpace® 4400 Business Music System and ControlSpace® Engineered Sound Processor.

### Line input connections

When using a front-end signal processor, the included RCA cable may need to be modified. The wiring diagram for the zone amplifier line input RCA connectors is provided below.



### Loudspeaker connections

Refer to Section “Loudspeaker connections” on page 21 for instructions.

## Installation and Placement

### Importance of proper ventilation

For placement of the amplifier, keep the following in mind:

- Make sure that air can circulate freely around the amplifier for adequate ventilation. There are vents on the top, bottom, and sides.
- Do not cover or block amplifier vents.
- Do not enclose amplifier in a small space, such as a cabinet.
- Make sure the chassis is protected from heat and kept away from direct heat sources, such as heating vents and radiators.

**Caution:** Do not allow the chassis to exceed the maximum operating temperature of 40° C (104° F). Be aware of conditions in an enclosed rack that may increase the temperature above room-ambient conditions.

**Note:** If the amplifier becomes too hot, it will go into a thermal protection mode and mute all outputs.

### Placing on a flat surface

The amplifier can be placed on a flat, stable surface like a table, counter, or shelf. Plastic feet are included with the amplifier to protect the surface area, prevent the chassis from sliding, and allow heat to escape from the bottom vent.

**Note:** The included feet shall always be used when placing amplifier on a flat surface to ensure proper ventilation.

### Installing the feet on the amplifier

The included feet are comprised of two parts: a foot and a pin.

1. Place the amplifier upside-down on a flat, level surface on a protective covering to avoid scratching the top of the chassis.
2. Insert the four feet into the four holes on the bottom of the chassis.
3. Insert a pin into the hole on the foot.
4. Press down on the pin until the foot locks into place. Repeat for all four feet.

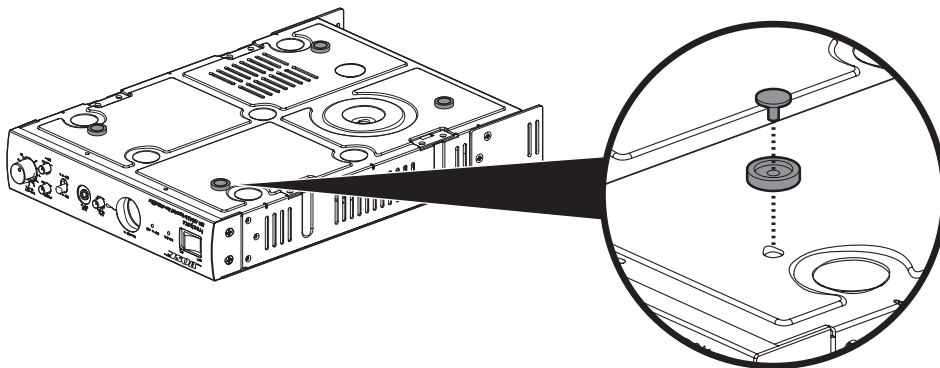

### Stacking units

One amplifier can be stacked on top of another when there is limited space available on a table, counter, or shelf.

**Note:** The included feet always shall be used on both amplifiers when stacking them to ensure proper ventilation.

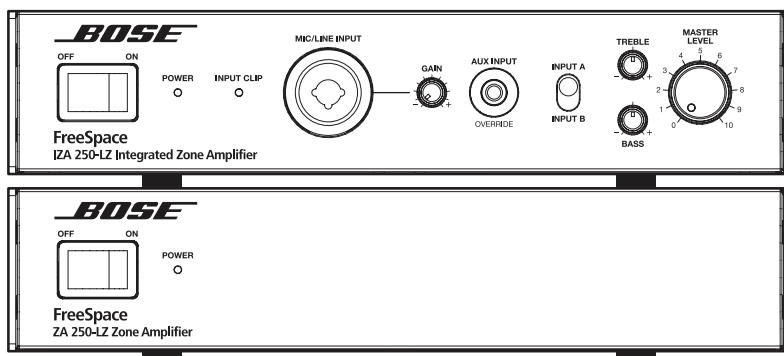

## Mounting in standard rack with Rack Mount Kit Accessory

An accessory Rack Mount Kit is available from Bose for installing one or two FreeSpace® amplifiers in a standard 19" 1 RU electronics rack.

The Rack Mount Kit includes:

- (2) link brackets
- (2) short rack ears
- (1) long rack ear
- (14) M3 x 0.5, 6 mm length Phillips flat-head machine screws

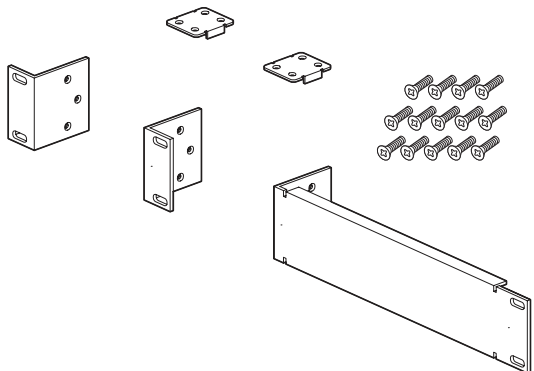

## Mounting a single amplifier

1. Attach one short rack ear to one side of the amplifier chassis with three (3) of the included screws.
2. Attach the long rack ear to the other side of the amplifier chassis with three (3) of the included screws.

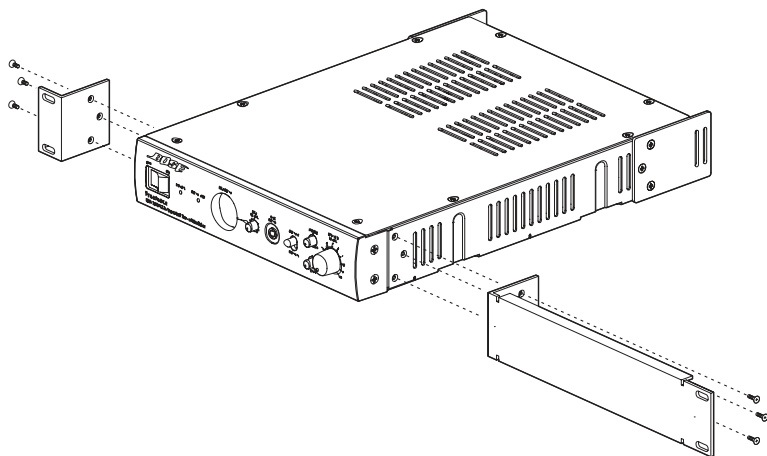

3. Mount amplifier in a rack with four (4) rack screws and washers (not included).

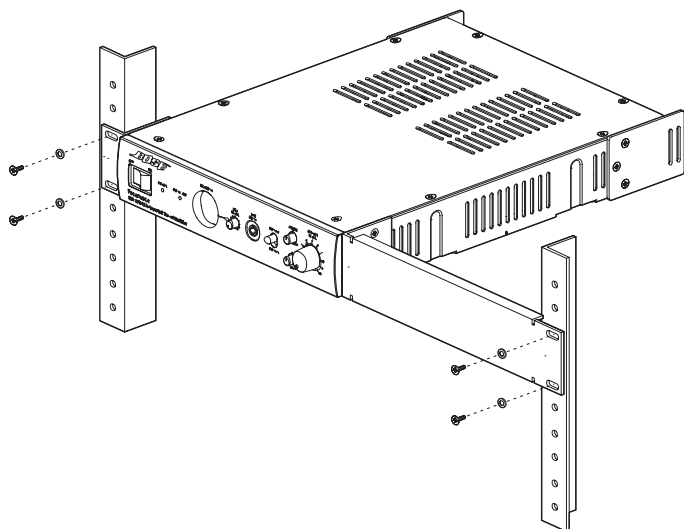

## Mounting two amplifiers

1. Remove rear rack ears from both amplifiers where they will meet in the middle. Then place the amplifiers upside-down on a flat, level surface on a protective covering to avoid scratching the top of the chassis.

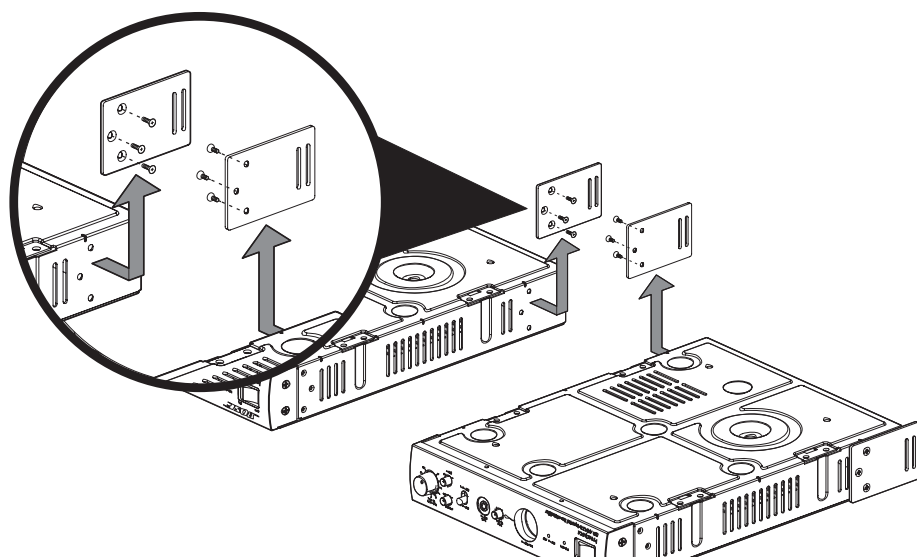

2. Attach a short rack ear to one side of each amplifier chassis with three (3) included screws.

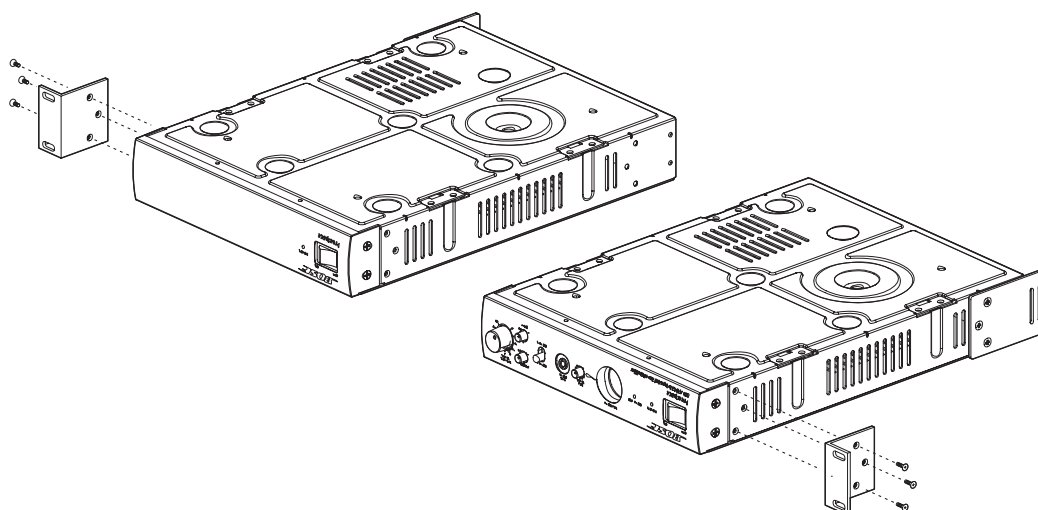



- Place the amplifiers side by side and attach the two (2) link brackets to the amplifier chassis with four (4) included screws each.

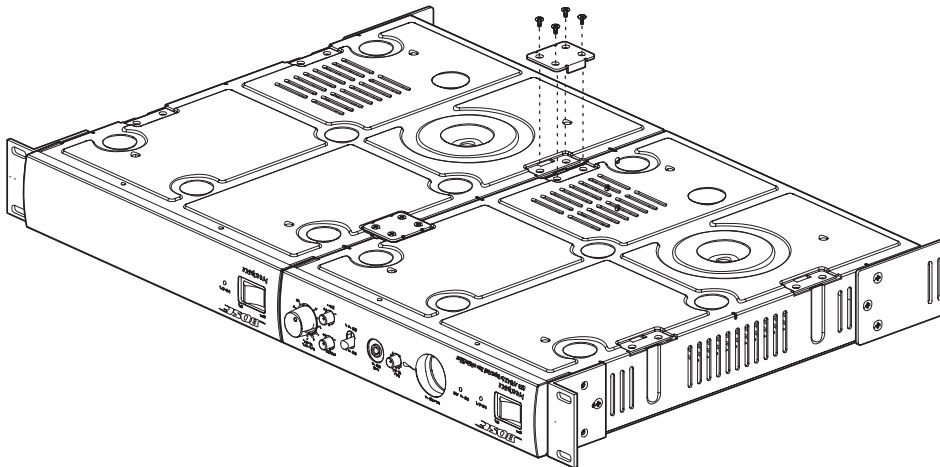

**CAUTION:** Only use the mounting hardware recommended by the rack manufacturer.

- Mount amplifier in rack with four (4) rack screws and washers (not included).

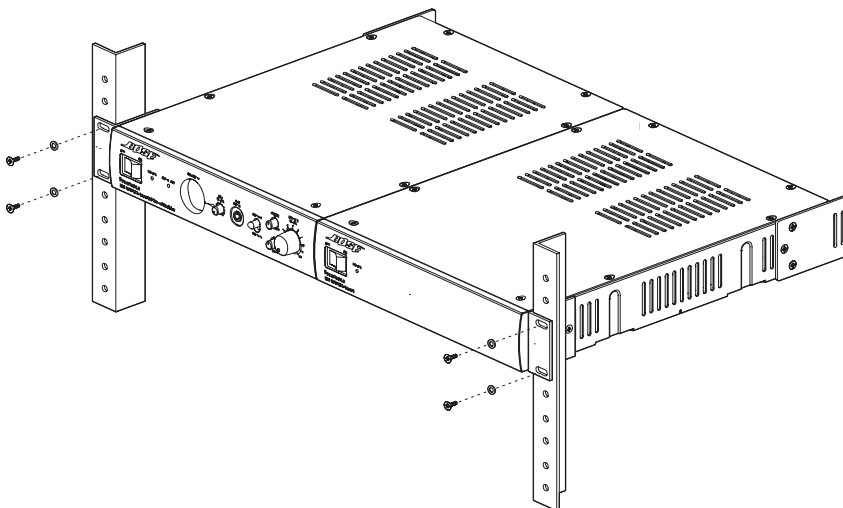

### Using the rear rack ears for strain relief

The slots on the rear rack ears can be used to provide strain relief with standard wire ties.

### Spacing requirements for rack-mounted amplifiers

Allow 1RU spacing above and below rack-mounted amplifiers to ensure sufficient spacing for ventilation. Additionally, the temperature of the rack should be controlled to ensure that amplifiers are not exposed to temperatures exceeding 40° C (104° F).

Troubleshooting

Problem	Solution
No power	<ul style="list-style-type: none"> <li>• Turn on power. Blue LED on front-panel will be visible when power is on.</li> <li>• Make sure the power cord is plugged in.</li> <li>• Try a different AC outlet that is working with another piece of equipment.</li> </ul>
Power is on, but no sound	<ul style="list-style-type: none"> <li>• Make sure the input source is turned on.</li> <li>• Verify that there is an input signal from the source.</li> <li>• Check the cable connections from the source to the amplifier.</li> <li>• Ensure the desired source (A/B) is selected on the front panel.</li> <li>• If a user interface is connected to the Remote connector on the rear panel, make sure the desired source (A/B) is selected on user interface (user interface overrides the front-panel source select).</li> <li>• Make sure the Master Level control is turned up.</li> <li>• If a user interface is connected to the Remote connector on the rear panel, make sure the volume control on the user interface is turned up (user interface overrides the front-panel Master Level control).</li> <li>• Make sure a 1/8" (3.5 mm) TRS input cable is not connected to the Aux Input. The Aux Input has a mechanical override feature so if an input cable is connected to it the selected Input A/B source will be automatically overridden - even if the Aux Input audio source is not playing or connected.</li> <li>• If a contact closure is connected to the Mute connector on the rear panel, check the switch to ensure the mute function has not been triggered.</li> <li>• If a source is connected to the Page connector on the rear panel, make sure it has not been triggered.</li> <li>• Make sure loudspeakers are connected properly.</li> <li>• Check that loudspeaker taps are set correctly.</li> <li>• Check that the amplifier has adequate ventilation. Improper ventilation could cause the amplifier to go into protection mode and no audio will be heard.</li> <li>• Ensure that the output wiring is correct. A short circuit will cause the amplifier to go into protection mode and no audio will be heard.</li> </ul>
Power is on, but sound is low	<ul style="list-style-type: none"> <li>• Verify that the audio input source output is turned up to a nominal level.</li> <li>• Check the cable connections from the source to the amplifier.</li> <li>• Increase input level of source with Gain controls on amplifier. Turn Gain knob up until you start seeing red Input Clip LED on front-panel. Then turn Gain down until red LED Input Clip does not engage.</li> <li>• Make sure Output Trim controls on amplifier are not turned down too much.</li> <li>• If a user interface is connected to the Remote connector on the rear panel, make sure the volume control on the user interface is turned up (user interface overrides the front-panel Master Level control).</li> </ul>
Sound is distorted	<ul style="list-style-type: none"> <li>• Verify that the Input Clip red LED on the front-panel is not lit. If LED is red, reduce the source output level or reduce the input gain.</li> <li>• If the input source signal is clean, verify that the loudspeakers are not overdriven or damaged. Check the loudspeaker tap setting.</li> </ul>
Unnatural sound	<ul style="list-style-type: none"> <li>• Verify that the proper EQ preset is selected for the loudspeakers being used. Use HPF (IZA 190-HZ) or FLAT (IZA 250-LZ) setting when using loudspeakers other than FreeSpace® FS2C/SE/P or FS4CE/SE loudspeakers.</li> <li>• Check the Treble and Bass controls on the front-panels.</li> <li>• Verify that the loudspeakers are wired correctly (+ to + and - to -).</li> </ul>

## AC Current Draw and Thermal Dissipation Information

IZA 250-LZ, AC Current Draw and Thermal Dissipation							
Test Signal & Power Level	Load Configuration (Note: Both IZA channels driven)	Total Audio Output, W	120VAC 60Hz. Line Current, A	230VAC 50Hz. Line Current, A	Thermal Dissipation, Max		
					Watts	BTU/hr.	kCal/hr.
Power On, Idling		0	0.23	0.16	37	127	32
1/8th Rated Power IEC65 Bandlimited Pink Noise 6dB Crest Factor FS2C/SE/P EQ Enabled	8 Ω / Ch	6	0.40	0.23	45	153	39
	4 Ω / Ch	13	0.48	0.29	53	181	46
1/3rd Rated Power IEC65 Bandlimited Pink Noise 6dB Crest Factor FS2C/SE/P EQ Enabled	8 Ω / Ch	17	0.63	0.37	63	215	54
	4 Ω / Ch	33	0.90	0.53	87	298	75

ZA 250-LZ, AC Current Draw and Thermal Dissipation							
Test Signal & Power Level	Load Configuration (Note: Both IZA channels driven)	Total Audio Output, W	120VAC 60Hz. Line Current, A	230VAC 50Hz. Line Current, A	Thermal Dissipation, Max		
					Watts	BTU/hr.	kCal/hr.
Power On, Idling		0	0.18	0.14	32	110	28
1/8th Rated Power IEC65 Bandlimited Pink Noise 6dB Crest Factor	8 Ω /Ch	6	0.30	0.22	42	143	36
	4 Ω /Ch	13	0.15	0.25	45	154	39
1/3rd Rated Power IEC65 Bandlimited Pink Noise 6dB Crest Factor	8 Ω /Ch	17	0.52	0.33	55	186	47
	4 Ω /Ch	33	0.90	0.50	82	279	70

IZA 190-HZ, AC Current Draw and Thermal Dissipation							
Test Signal & Power Level	Load Configuration (Note: Both IZA channels driven)	Total Audio Output, W	120VAC 60Hz. Line Current, A	230VAC 50Hz. Line Current, A	Thermal Dissipation, Max		
					Watts	BTU/hr.	kCal/hr.
Power On, Idling		0	0.21	0.17	40	136	34
1/8th Rated Power IEC65 Bandlimited Pink Noise 6dB Crest Factor FS2C/SE/P EQ Enabled	70V/Ch	11	0.46	0.28	53	180	45
	100V/Ch	11	0.52	0.32	61	210	53
1/3rd Rated Power IEC65 Bandlimited Pink Noise 6dB Crest Factor FS2C/SE/P EQ Enabled	70V/Ch	30	0.89	0.47	78	266	67
	100V/Ch	30	0.82	0.46	76	259	65

ZA 190-HZ, AC Current Draw and Thermal Dissipation							
Test Signal & Power Level	Load Configuration (Note: Both IZA channels driven)	Total Audio Output, W	120VAC 60Hz. Line Current, A	230VAC 50Hz. Line Current, A	Thermal Dissipation, Max		
					Watts	BTU/hr.	kCal/hr.
Power On, Idling		0	0.15	0.14	32	108	27
1/8th Rated Power IEC65 Bandlimited Pink Noise 6dB Crest Factor	70V/Ch	11	0.42	0.25	47	161	41
	100V/Ch	11	0.35	0.24	44	150	38
1/3rd Rated Power IEC65 Bandlimited Pink Noise 6dB Crest Factor	70V/Ch	30	0.88	0.49	84	285	72
	100V/Ch	30	0.75	0.45	74	251	63

## IZA 250-LZ/190-HZ Specifications

Power Rating				
	Model IZA 250-LZ		Model IZA 190-HZ	
Amplifier Power	2 x 50 W @ 4 Ω; 2 x 25 W @ 8 Ω		1 x 90 W 70/100V	
Audio Performance Specifications				
	Model IZA 250-LZ		Model IZA 190-HZ	
Frequency Response	40 Hz - 20 kHz (+0/-3 dB, @ 1 W reference 1 kHz)		60 Hz - 20 kHz (+0/-3 dB, @ 1 W reference 1 kHz)	
THD + N	≤0.3% (at full rated power 4 Ω)		≤1% (at full rated power)	
Channel Separation (Crosstalk)	≤-60 dB (below rated power, 1 kHz)		≤-60 dB (below rated power, 1 kHz)	
Dynamic Range	88 dB		88 dB	
Audio Inputs				
	Line Inputs	Mic/Line Input	Page Input	Aux Input
Input Channels	2 (unbalanced line)	1 (balanced mic/line)	1 (balanced mic)	1 (unbalanced line)
Input Connectors	Stereo RCA	Combo XLR - 1/4" (6.5mm) TRS	4-pin Euroblock	1/8" (3.5 mm) TRS
Input Range	-10 dBV - +10 dBV	-60 dBV - +10 dBV	-60 dBV - +10 dBV	0 dBV - +10 dBV
Adjustment Range	-20 dB - +20 dB	0 dB - +50 dB	0 dB - +50 dB	Fixed
Input Impedance	20 kΩ	2 kΩ	2 kΩ	20 kΩ
Max Input Level	+10 dBV	+10 dBV	+10 dBV	+10 dBV
Sensitivity	N/A	N/A	N/A	N/A
Nominal Input Level	0 dBV	-40 dBV	-40 dBV	0 dBV
Audio Outputs				
	Amplifier Outputs (IZA 250-LZ)	Amplifier Outputs (IZA 190-HZ)	Auxiliary Outputs	
Outputs	2	1	1 (unbalanced)	
Connectors, Output	2-terminal barrier strip	3-pin inverted Euroblock	Stereo RCA	
Output Impedance	4 Ω	N/A	400 Ω	
Nominal Output Level	2 x 50 W @ 4 Ω; 2 x 25 W @ 8 Ω	1 x 90 W 70/100V	0 dBV (max)	
Integrated DSP				
A/D and D/A Converters	24-bit/48 kHz			
Loudspeaker Presets	IZA 190-HZ: HPF (60 Hz), FS2C/SE/P, FS4CE/SE IZA 250-LZ: FLAT, FS2C/SE/P, FS4CE/SE			
Audio Latency	10.4 ms (Input to Speaker Output or Aux Output)			

Controls and Indicators	
LED Status Indicators	Power - blue; Input Clip - red (-3 dBFS)
Controls, Front Panel	Power On/Off, Input Select (A/B), Tone Controls (Treble/Bass), Mic/Line Gain, Master Level
Controls, Rear Panel	Amplifier Mode DIP Switch, Loudspeaker EQ Preset Selector, Input Gain (A/B/Page Mic), Output Trim
Electrical Specifications	
Mains Voltage	100V AC - 240V AC (+ /- 10%, 50/60 Hz)
AC Power Consumption	15 W (Idle), 200 W (Max)
AC Mains Connector	Standard IEC (C14)
Peak Inrush Current	13.9 Amps (230V/50 Hz), 7.6 Amps (120V/60 Hz)
Overload Protection	High temperature, short
Physical	
Rack Space Units	1 RU high, half rack wide
Dimensions	12.2" L x 8.4" W x 1.8" H (310 mm x 214 mm x 45 mm)
Shipping Weight	250-LZ: 6.7 lb (3.0 kg), 190-HZ: 9.0 lb (4.1 kg)
Product Weight	250-LZ: 4.8 lb (2.2 kg), 190-HZ: 7.0 lb (3.2 kg)
Cooling System	Natural convection
General	
Inputs (Control)	Control Center CC-1 (volume control) or CC-2 (volume and A/B source selection), Mute input for amplifier muting via contact closure
Accessories	ZA 250-LZ zone amplifier, ZA 190-HZ zone amplifier, ZA 2120-HZA zone amplifier, ZA 2120-LZA zone amplifier, ControlCenter CC-1 (volume control), ControlCenter CC-2 (volume and A/B source selection), Rack Mount Kit

## ZA 250-LZ/190-HZ Specifications

Power Rating		
	Model ZA 250-LZ	Model ZA 190-HZ
Amplifier Power	2 x 50 W @ 4 Ω; 2 x 25 W @ 8 Ω	1 x 90 W 70/100V
Audio Performance Specifications		
	Model ZA 250-LZ	Model ZA 190-HZ
Frequency Response	20 Hz - 20 kHz (+0/-3 dB, @ 1 W reference 1 kHz)	60 Hz - 20 kHz (+0/-3 dB, @ 1 W reference 1 kHz)
THD + N	≤0.3% (at full rated power 4 Ω)	≤1% (at full rated power)
Channel Separation (Crosstalk)	≤-60 dB (below rated power, 1 kHz)	≤-60 dB (below rated power, 1 kHz)
Dynamic Range	88 dB	88 dB
Audio Inputs		
	Line Inputs	
Input Channels	1 unbalanced	
Input Connectors	Stereo RCA	
Input Range	-10 dBV - +10dBV	
Input Impedance	20 K Ω	
Max Input Level	+10 dBV	
Nominal Input Level	0 dBV	
Audio Outputs		
	Model ZA 250-LZ	Model ZA 190-HZ
Outputs	2	1
Connectors, Output	2-terminal barrier strip	3-pin inverted Euroblock
Nominal Output Level	2 x 50 W @ 4 Ω (Min); 2 x 25 W @ 8 Ω	1 x 90 W 70/100V
Controls and Indicators		
LED Status Indicators	Power - blue	
Controls, Front Panel	Power On/Off	
Controls, Rear Panel	Mono/Stereo Amplifier Mode Switch (ZA 250-LZ only), Output Trim	
Electrical Specifications		
Mains Voltage	100V AC - 240V AC (+/- 10%, 50/60 Hz)	
AC Power Consumption	15 W (Idle), 200 W (Max)	
AC Mains Connector	Standard IEC (C14)	
Peak Inrush Current	13.9 Amps (230V/50 Hz), 7.6 Amps (120V/60 Hz)	
Overload Protection	High temperature, short	

Physical	
Rack Space Units	1 RU high, half rack wide
Dimensions	11.9" L x 8.4" W x 1.8" H (302 mm x 214 mm x 45 mm)
Shipping Weight	250-LZ: 6.4 lb (2.9 kg), 190-HZ: 8.6 lb (3.9 kg)
Product Weight	250-LZ: 4.4 lb (2.0 kg), 190-HZ: 6.7 lb (3.0 kg)
Cooling System	Natural convection
General	
Accessories	Rack Mount Kit

## **Importer Information**

**China Importer:** Bose Electronics (Shanghai) Company Limited, Part C, Plant 9, No. 353 North Riyang Road, China (Shanghai) Pilot Free Trade Zone

**EU Importer:** Bose Products B.V., Gorslaan 60, 1441 RG Purmerend, The Netherlands

**Mexico Importer:** Bose de México, S. de R.L. de C.V. , Paseo de las Palmas 405-204, Lomas de Chapultepec, 11000 México, D.F. For importer & service information: +5255 (5202) 3545

**Taiwan Importer:** Bose Taiwan Branch, 9F-A1, No. 10, Section 3, Minsheng East Road, Taipei City 104, Taiwan. Phone Number: +886-2-2514 7676











857567-0010

© 2019 Bose Corporation. All rights reserved.  
The Mountain, Framingham, MA 01701-9168 USA  
PRO.BOSE.COM  
AM857567 Rev. 00  
December 2019

